

Pipe Inspection Camera System

Operation Manual



Read this Operation Manual carefully before using this tool

[INTRODUCTION]

The pipe inspection camera system is a powerful set of tools that helps you locate and diagnose problems in a pipeline system.

The system is widely used in inspections of Sewer, central air conditioning, chimney, plumbing, building, cable pipe and pipes ventilation systems and other places.

[PRECAUTIONS]

Read all safety warnings and instructions. Failure to follow warnings and instructions may result in electric shock, fire and/or serious injury.

Save this operation manual for future reference.

1. Do not operate this device in explosive atmospheres, such as in the presence of flammable liquids, gases, hazardous chemicals, superheated liquid or heavy dust. It may create sparks which may ignite the dust or fumes.
2. The camera head and the push cable are waterproof, however, the DVR and connector cable are not. Do not expose them to water or rain. This increases the risk of electrical shock.
3. Avoid using the device in environments of extreme cold, heat or humidity as it may damage the device.
4. Do not drop or press hard on the device.
5. Always backup your data before connecting your SD memory card to this system. The manufacturer is not responsible for any data of damage on your SD memory card for any reason.
6. Do not disconnect the unit while recording or playing back. It may damage the unit and/or the SD memory card.
7. Only qualified person are allowed to repair this device. Service or maintenance performed by unqualified person could result in injury.
8. Do not use this device in places where there is high voltage equipment. The device doesn't contain high voltage protection and isolation.
9. Check or maintain this device regularly, repair it or replace new parts if there is any damage.

[APPLICATION AND KNOW YOUR TOOL]

APPLICATION

Suitable for pipes at diameter of 50mm-300mm.

KNOW YOUR TOOL

The pipe inspection camera system includes the following four main parts: camera head, push cable, keyboard text writer unit and DVR.

The camera features 512Hz transmitter (optional), self-leveling device, adjustable brightness LEDs, high quality anti-scratch sapphire glass lens cover; stainless steel housing; The sapphire glass cover and stainless steel housing can protect the camera from scratching, knocking, etc.

The flexible stainless steel spring and other related components provide a flexible transition; which makes the push cable be easier to pass through bended pipes.

Battery is built into LCD to provide power for camera and DVR monitor.

Camera

1. Stainless steel shell
2. Leds
3. Isolation ring
4. Sapphire lens cover

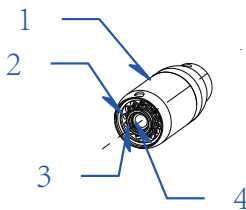

Figure 1. Camera

Remote control

1. Menu settings
2. Playback mode
3. Reserved function expansion
4. Image zoom/exit and return
5. Upward selection
6. Confirm/Pause
7. Select left/rewind
8. Select right/fast forward
9. Select downward
10. Image rotation
11. LED brightness
12. Start/stop recording
13. Photo shoot button

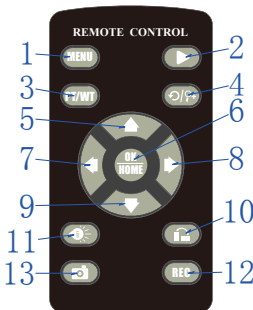

Figure 2. Remote control

Keyboard Text Writer

1. Meter-Zero(Meter Counter Zero Set Button)
2. Cam (connect to DVR)
3. USB 2.0 female connect
4. Wireless Keyboard Receiver
5. Waterproof Cap

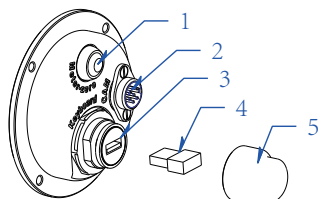

Figure 3.Keyboard text writer

LCD display has two options, single DVR or toolbox unit

DVR and Bracket

1. Playback mode
2. Select left/rewind
3. Menu settings
4. Charging and working indicator
5. Image zoom/exit and return
6. Confirmation/Pause
7. Downward selection
8. LED brightness
9. Remote control receiver
10. Start/stop recording
11. Select right/fast forward
12. Photo shoot button
13. Image rotation
14. Upward selection
15. Reserved function expansion
16. Switch button
17. USB 2.0 To PC
18. SD card slot
19. High-definition color LCD display
20. Sunshade
21. Aviation cable video head
- 22.Wheel clip
- 23.Wing nuts
- 24.Heavy hex bolts

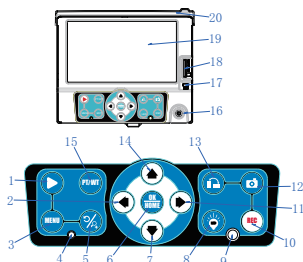

Figure 4.DVR

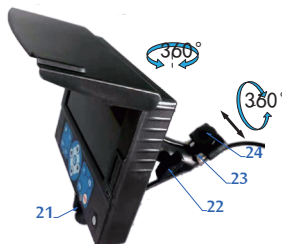

Figure 5.DVR and bracket

Toolbox Unit

1. Playback mode
2. Select left/rewind
3. Menu settings
4. Charging and working indicator
5. Image zoom/exit and return
6. Confirmation/pause
7. Downward selection
8. LED brightness
9. Remote control receiver
10. Start/stop recording
11. Select right/fast forward
12. Photo shoot button
13. Image rotation
14. Upward selection
15. Switch button
- 16 SD card slot
17. High-definition color LCD display
18. Sunshade
19. Toolbox lock
20. DC input
21. Meter counter zero-set button
22. Wireless keyboard
23. Aviation socket

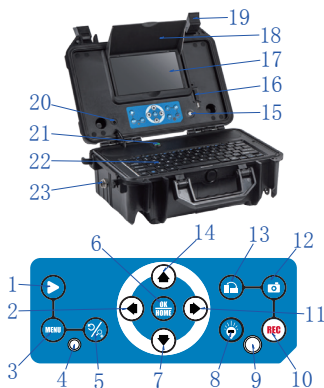

Figure 6.Toolbox unit

[DESCRIPTION SPECIFICATIONS AND STANDARD EQUIPMENT]

Product parameters

	ITEM	PARAMETER
General	Operating Temperature	-10~50°C/+14~+122°F
	Operating Humidity	30%RH~90%RH
	Storage Temperature	-20~60°C/+4~+140°F
	Power adapter	Input:100-240V AC, Output:12V DC 1500mA
	MEAS.	58.5×33.5×75.0cm (LxWxH)
	Weight	13.5-21.2Kg(Approx)
Camera	Sensor	1/3" Sony CCD
	TV-Line	480 TV-Line
	View Angle	120°
	Self leveling	Built-in
	Focus Distance	20cm (approx)
	Depth of field	100cm(approx)
	Camera Size	Φ38mm×81mm(Main body)
	Front Lens	Sapphire
	Shell Material	304#Stainless Steel
	Lighting	Built-in 12×LED (White)
	Water-Proof	20m water (Camera fix on Cable)
Power Supply	DC12V	
Current Consume	60mA (LED OFF);140mA (LED ON)	
DVR	Screen	Super bright high-definition color LCD screen
	Screen Resolution	1024×600
	Image	Support image rotation
	Video Resolution	AHD 1080P / AHD 720P / CVBS D1
	Video Encoding	High Compression / H. 264
	Photograph Resolution	1920×1080
	Audio Recording	Support Local Sound
	Out Put	TV output or Audio and TV output
	External Memory	Support SD Memory Card up to 64GB
	Data port	USB2.0 To PC
	LED Driver	Built-in Dimmer
	Play Back	Video and Photo
	Language	Simplified Chinese, English, Traditional Chinese, Japanese, Korean, Russian, German, French, Italian, Spanish, Portuguese, Thai
	Power Supply	DC 6~12V input
	Current Consume	700mA Max
	Battery Capacity	7.4V 5200mAh Li-ion Battery
A Single Charge Work Time	About 6 hour	
Charge Time	About 8 hour	
Keyboard Text Writer	Keyboard Compatibility	Support Specific PC Wireless keyboard
	Typing Language	English
	Max Characters	384
	Hide Characters	Quick One Key hiding
	Precision of Meter	Counter ±1%
	Meter and Feet Switch	Support
	Set Zero	Support
	Power Consume	40mA @ 12V DC
Waterproof	P66 (for connection ports panel only)	
Cable Wheel	Cable Diameter	Φ6.8 mm
	Cable Length	40/50/60meter (Selectable)
Tool Box	Size	380×260×150mm(L×W×H)
	Box color	Black

STANDARD CONFIGURATION

Frame Assembly

- M1. Frame
- M2. Coil and push rod
- M3. Meter counter device
- M4. Guide spring
- M5. Camera
- M6. Handle
- M7. DVR and bracket
- M8. U-pipe

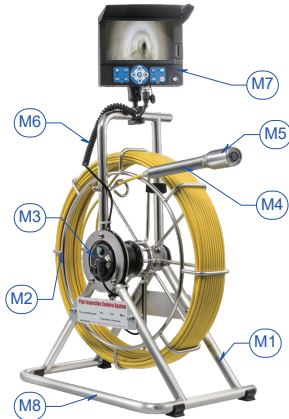

Figure 7. Frame assembly

Tools kit

- P1. 5mm Screwdriver
- P2. Operation manual
- P3. 13mm Inner hexagon spanner
- P4. 2.5mm Hexagon spanner
- P5. 72 Roller Skid
- P6. Car charger
- P7. Power adapter
- P8. 5mm Hexagon spanner
- P9. 120 universal Skid
- P10. DVR Remote control
- P11. Camera o-ring
- P12. 3mm Screwdriver

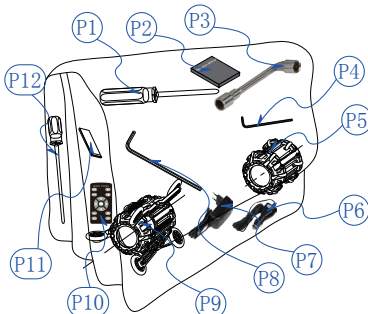

Figure 8. Tools kit

STANDARD CONFIGURATION

Frame Assembly

- M1. Frame
- M2. Coil and push rod
- M3. Meter counter device
- M4. Guide spring
- M5. Camera
- M6. Cable
- M7. Tool box bracket
- M8. U-pipe

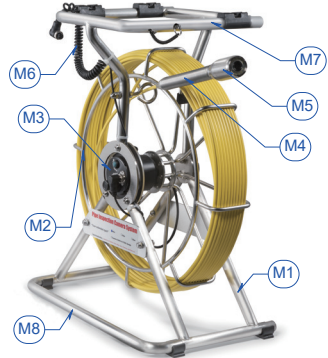

Figure 9. Frame assembly

Toolbox unit

- B1 DVR Remote control
- B2 Car charger
- B3 Power adapter
- B4 5mm Screwdriver
- B5 Camera o-ring



Figure 10. Toolbox unit

Tools kit

- P1. 5mm Hexagon spanner
- P2. 2.5mm Hexagon spanner
- P3. 120 universal Skid
- P4. 3mm Screwdriver
- P5. Operation manual
- P6. 72 Roller Skid
- P7. 13mm Inner hexagon spanner

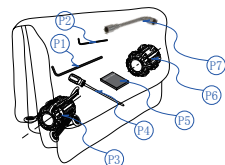

Figure 11. Tools kit

[INSTALLATION]

To reduce the risk of serious injury during use, follow these procedures for proper assembly.

1. Install Camera Head (See Figure 12)

Take out camera, grip the guide spring and screw the camera head tightly clockwise. Ensure the seal ring and the gold pins are in good status before installing camera head.

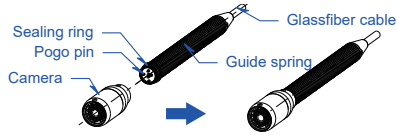

Figure 12. Install camera head

2. Install Roller Skid

Roller skids are used to keep the camera head in the center of different sized pipes and also to keep camera head away from mud at the bottom of pipes, in order to keep camera head clean and also view best quality images.

If you choose 72/120 skid, please install:

- 1) Install 72 Roller Skid. (See Figure 13)
- 2) Install 120 Roller Skid. (See Figure 14)

Please select the appropriate skids according to the size of the pipe, put the camera into the skids, rotate to find the right position, fixed the lock-ring.

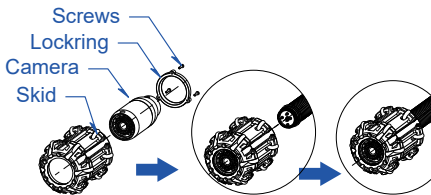

Figure 13. 72 Roller skid

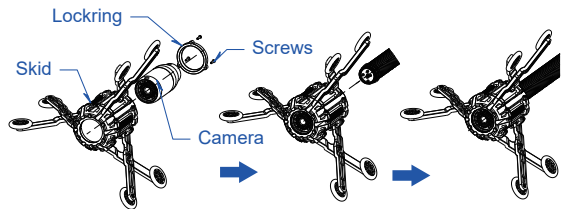

Figure 14. 120 Roller skid

If you choose 78/134 skid, 60 ball skid, please install

- 1) Install 78 skid and 60 ball skid. (Figure 15)
- 2) Install the 134 skid and 60 ball skid. (Figure 16)

Please choose a suitable skids according to the size of the pipe, put the camera into the skid, and tighten the locking sleeve;

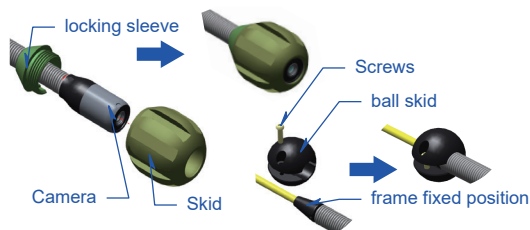

Figure 15. 78 Roller skid

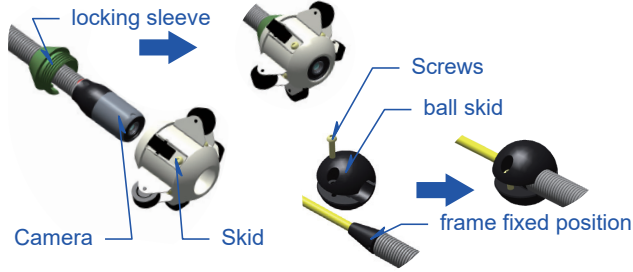

Figure 16. 134 Roller skid

3. If you choosed the toolbox unit, please install the toolbox unit (Figure 17)

Take the toolbox unit out of the package, align the slot on the fixing seat, assemble the toolbox unit on the toolbox bracket, and fix the quick-release plug to the fixing hole on the toolbox unit.

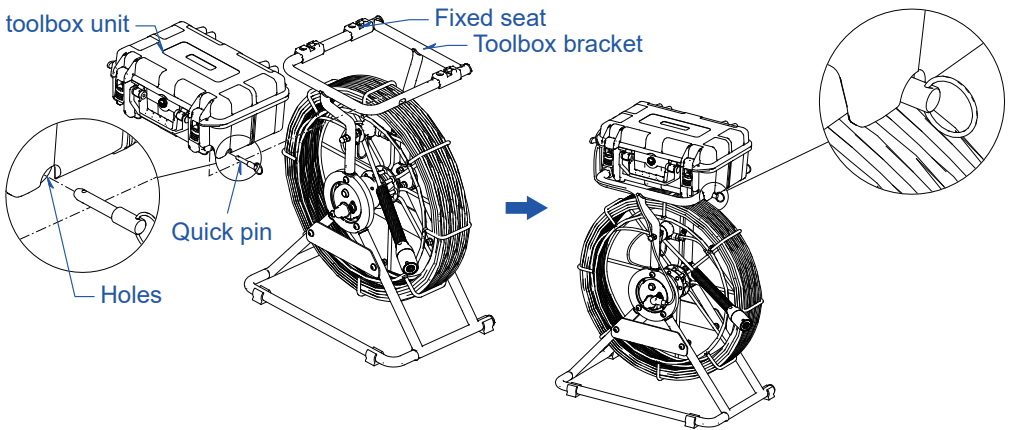

Figure 17. Install toolbox unit

[FUNCTION GUIDE AND OPERATING INSTRUCTIONS]

DVR icon introduction

1. LED brightness
2. Meter counter display (meters)
3. Meter counter display (feet)
4. Record indication
5. Time indication
6. Date indication
7. Sound recording indication
8. SD card
9. Battery level indicator



Figure 18. Screen icon

[DVR Operation]

1. Insert the card

Please insert the SD card before using the device. (Hint: In order to ensure the normal operation of the device, please use a Class10 high-speed branded SD card. Please format the SD card for the first time using it)

2. Turn On/Off

Press the  key to turn on/off, and it will automatically enter the real-time image mode when it is turned on.

3. Function Buttons

Light adjustment: In the real-time image mode, press the  to decrease or increase the brightness of the LEDs.

Image rotation: In real-time image mode, press the  to realize image rotation.

Take a photo: In the real-time image mode, press the  to take a photo, and the photo will be saved in the photo folder of the SD card.

Record a Video: In the real-time image mode, press the  to start/stop recording a video, and the video file will be saved in the video folder of the SD card.













Menu setting: In the real-time image mode, press the  to enter the menu setting.

Image magnification: In the real-time image mode, press the  to realize image magnification.

Exit/Return: During parameter setting and file management, press  to exit or return.

4. Parameter Settings

Under real-time image mode, press  to enter the parameter setting; press  and  to select the menu you need to change, press  and  to select the submenu that you need to change, and press  to confirm the submenu you need to change; press  and  to select the value you need to change, press  to confirm and save the settings; press  to exit the setting.

4.1 Recording settings

Video size: To set the resolution of the recorded video files.

Loop recording: 2min/5min/10min, the recorded files are divided according to the set size, and the system will automatically prompt on screen when the card is full.

Encoding type: To set video compression format according to the requirements of use.

Sound switch: you can turn on or off the recording sound.

Exposure setting: The sensitivity of photo and video shooting can be set according to the brightness of the environment in order to improve the shooting effect.

4.2 Display settings:

Screen brightness: You can set the display brightness of the screen.

4.3 System settings:

Format: The capacity of the SD card can be displayed, and the user can format the SD card.

Language settings: Simplified Chinese, English, Traditional Chinese, Japanese, Korean, Russian, German, French, Italian, Spanish, Portuguese, Thai

Light source frequency: different light source frequencies can be set according to actual needs.

Volume: To set the volume of the recorded sound.

Date and time: To adjust date and time.



Time zone selection: You can choose the actual time zone of your area.





Restore factory settings: In case of abnormality, the factory settings can be restored.



Device information: system version information.

5. File Management







In the real-time image mode, press the  key to enter the folder, and the user can browse, play or delete recorded videos or photos.

Browse files: After entering the folder, press the  and  keys to browse the media files.

Playback files: After entering the folder, press the  and  keys to select the media file to be played back, press the  key to play or pause the play. During playing a video or photo, press the  key to play the previous file, press  Key to play the next file.

Fast forward and fast rewind: During playing a video, press the  key to fast forward playback, press the  key to fast reverse playback, and press the  key to pause playback.

Delete Files:

- a. After entering the folder, press the [>] and [>] keys to select the media file to be deleted. Press the [>] key to enter the delete mode, press the [>] and [>] keys to select whether or not to delete the media file, and press the [>] key to delete or cancel the deletion of the media file.
- b. During playing back a file, you can also delete or cancel the deletion of media files according to the above steps.

[METER COUNTER OPERATION]

1. Press the meter-zero button to set the meter to zero on screen display.
2. Change the unit of length or the total length of push cable, please refer to 'F2 backstage operation' contents in the wireless keyboard operation.

Note1: The deviation of MC will increase if the total length is not correct. You need to select the correct total length to decrease the deviation. Use this function to change the displayed total length when the push cable is cut off for more than 3 meters.

Note 2: Turn on the system before pulling out the push cable from the cable reel. It can decrease the deviation of the MC.

[WIRELESS KEYBOARD OPERATION]

The keyboard text writer is used to type characters with the wireless keyboard and display on screen. The characters can be displayed in recorded video or captured photo. It supports max. 384 characters and quick one key hiding characters.

Text Input

1. Typing characters with wireless keyboard. Using arrow key to move cursor, backspace key to delete ,and enter key to change a new line.
2. Esc key to hide or appear all characters.Ctrl + Del to delete all characters.
3. You can type and edit characters while recording, the typing and editing will be recorded in the video files.
4. The typed characters will be stored in memory.

Backstage Operation

You can press "F1" or "F2" key within 5 seconds after DVR monitor starts to enter F1 or F2 backstage operation.

1. The first line is reserved for user to type company name, name of operator, phone number etc., and these contents won't be hid by pushing ESC button. You can edit the contents by using F1 key, and press Enter key to save and exit.
2. Please refer to meter counter operation prior to this operation. Using F2 background key to select the unit of length or the total length of push cable (this is designed in case the total length of push cable is changed). When the "L=" flashes, press up or down arrow key to select the unit of length, or select the correct total length. Press enter key to save and exit.

[PUSH CABLE AND CAMERA OPERATION]

At the job site

1. Always wear rubber gloves to operate the camera for health and safety reasons. Properly positioning the cable reel will save time and strength to push out and in the cable, and minimize the rate of equipment damage.
 - When pushing, the end of your stroke should be as close to the entry as possible. Standing too far back with an excess of cable between your hands and the entry may cause the cable to fold on itself outside the entry and damage the cable.
 - Try to keep the push cable away from sharp edge of a pipe entry because this may cause damage. If the camera does not seem to go any farther, DO NOT FORCE TO PUSH THE CAMERA! Try another entry if possible.

NOTE! Hands should be close to the line opening. DONOT catch the cable on the edge of an entry and continue to push.

2. Always try to run water down the pipe under going inspection. This will keep the system much cleaner, and allow you to push noticeably farther with less friction. If the water is preventing you from seeing an area of importance, temporarily turn it off.
3. When push the push cable through the pipeline by steady and slowly, a short distance entry per time, keeps the hands at the entrance, so that can control the push cable and prevent it stuck, bent or scratch.
4. When inspecting a pipe, most of the time a slow steady push through the system works the best. At changes in direction such as P-traps, Tee's, Y's, Elbows, etc. It is usually necessary to give a little extra push in the bends. Back the camera head approximately 8" (20cm) from the bend, if necessary, and give it a quick push, "popping" the camera through a turn, using the least amount of force required. Try to be as gentle as possible, and do not hammer or snap the camera head through corners. After some practice, you may learn that the best way to inspect a section of pipe is to push the camera through quickly. Then draw the camera back home slowly and evenly.
5. Make sure the sapphire window is clean prior to entry. Some users claim that a slight film of detergent on the lens minimizes the possibility of grease sticking to the port. If necessary, take advantage of any standing water in the pipe to wash the front of the camera by jiggling it in the water.
6. When you place the camera head into the pipe remember, as the materials of pipe vary, it will be necessary to adjust the lighting settings to maximize picture quality.
7. The system can travel through multiple 45 and 90 degree bends and wyes. Do not, however, try to force it through a P-trap or tee if there is a large amount of resistance.

NOTE! Do not try to use the camera head to clear obstructions. This System is a diagnostic tool, not a drain cleaner. Using the camera head to clear obstructions could damage the camera head or cause it to be caught in the obstruction.

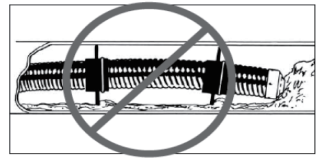

Figure 19. Improper operation

8. Do not attempt to remove or stores push cable on the reel solely by turning the reel itself. You can manually push or pull cable from the reel and wind or unwind it.
9. If the camera sits in a pipe, or an enclosed environment, heat will build-up. This may lead to the camera head overheating which will cause fuzzy lines to appear on the monitor. In the event, this happens, turn off the system, remove the camera from the pipe (or enclosed environment) and let the camera head cool for 10 to 15 minutes. Running water into the line will also help cool the camera head. Always use the minimum illumination required to maximize picture quality and to avoid excessive heat build-up.

NOTE! The camera head can get HOT! When finished with your inspection, or if taking a prolonged break in the middle of the inspection, turn off the system.

Retrieving the push cable

1. Once the inspection has been completed, pull the push cable back with slow, steady force. Do not force the push cable or exert excessive force. This could damage the camera or push cable. The push cable may get hung up while being retrieved, and may need to be manipulated as did during insertion.
2. While take back the push cable, running water can be used to flush down the push cable. After recycling, you can wipe the push cable with a towel.

Note! NEVER USE SOLVENTS to clean any part of the system. Substances like acetone and other harsh chemicals can cause cracking of the camera ring, which could affect waterproofing.

3. Storing the push cable into the cable reel. One hand holds the push cable, the other hand close to the cable wheel. Slowly and gently push the push cable slide via the hook of the handle, cable reel will rotate and store the push cable inside.

Note! The hands should be close to the cable wheel when storing the push cable. Push the push cable a small piece every try. Push a long distance can cause the push cable bend or broken.

[BATTERY SAFETY AND USING GUIDE]

Using safety

Read the following battery precautions before charger, to reduce the risk of electrical shock.

1. Recharge batteries with accessory charging units.
2. Check the power units every time before using the equipment, be sure no problem, use of unauthorized parts may result in electrical shock, fire and/or serious personal injury or damage other instruments and system.
3. Never connects the car charger to any 24 volt cigarette lighter slot. It will harm the battery and DVR.
4. Do not short circuit, it may cause fire, electrical shock.
5. Do not charge the battery under rain or wet conditions. Water entering the charger will increase the risk of electrical shock.
6. If the charger and battery are damaged, do not use or stop to charge. It may cause electrical shock.
7. Don't disassemble the case, only qualified repair person can repair and maintenance.
8. Properly dispose of the battery. Exposure to high temperatures can cause the battery to explode. So do not dispose of in a fire. Some countries have regulations concerning battery disposal. Please follow all applicable regulations.
9. Do not touch anything which out from battery, which would burn or damage the skin, once touches please flush with water. If in eyes, immediately get medical help fast.

Using Guide

Follow the steps as below to reduce the injury of the electric shock.

1. Power indicator LED will be red during charging, will be turned to green when charged fully. If battery empty for a long term, it will pre-charge the battery automatically in 10 minutes, and LED will be blinking in red.
2. It needs about 8 hours to charge the battery fully. The battery can charge online, charging and supplying of work will not increase charging times.
3. User can use a power adaptor or car charger to charge the battery. If no use in a long term, take a recharge per 6 month, to ensure the battery in normal working status.

[OTHERS]

Troubleshooting

Problem	Probable fault location	Solution
No image	Cable connection faulty or loosely	Check cable connection, clean and reconnect if necessary
	Camera connector soiled	Clean the camera connector
	Wrong SD memory card	Turu off power and replace SD card
	Wrong setting	Enter the setup menu and select reset
DVR Can not boot	No power	Recharge
	Transient short circuit in the cable cause the battery short circuit protection	Recharge the DVR more than 2 seconds with adaptor or car-charger to activate the battery
The deviation of MC more than 1%	select the wrong total length	Re-select the correct total length. You can press F2 key when the machine boot within 5 sec to enter background to select it
	Pull out cable more than 3 meters before turning on the system	Turn on the system before pulling out the push cable from the cable reel
Can not input Characters	The wireless keyboard low battery	Chang battery
	Wireless Keyboard or Receiver fault	Check the Keyboard Receiver and the keyboard on a PC
DVR charging indicator lights up green and cannot be charged	The battery temperature exceeds the range of -5~+48°C	Put the product under normal temperature for 30 minutes to automatically resume charging
When charging, the yellow and green charging indicator lights are not on	Power adapter failure	Replace a power adapter

Camera 1-323 : 38mm camera head with buil-in 512Hz Sonde (Optional)

Type	Item	Parameter
Image	Sensor	1/3" SONY CCD
	TV-Line	480 TV-Line
	View Angle	120°
	Focus Distance	20cm (approx)
	Depth-of-Field	100cm(approx)
	Front Lens	Sapphire
Transmitter	Frequency	512Hz
	Transmit Mode	Constant
	Transmission Distance	6 meters open area (max)

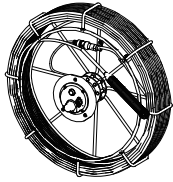









Figure 20.Camera 1-323

Part Number List

No.	Part Number	Part Name	Specifications	Picture
1	1-312	Camera Head	Sony CCD 480TVL, $\Phi 38 \times 81$ mm, 120° View Angle Self-Leveling	
2	1-323	Camera Head	Sony CCD 480TVL $\Phi 38 \times 81$ mm, 120° View Angle Self-Leveling With 512Hz Transmitter	
3	8-934	Roller Skid	72mm Roller Skid	
4	8-945	Roller Skid	120mm Roller Skid	
5	5-623	DVR	7-Inch Video Recorder, Built-In Battery	
6	2-312	Adaptor	DC 12V 1.5A Adaptor	
7	2-323	Car Charger	DC 12V 2A Car Charger	
8	3-412	Remote Control	13 Key DVR Remote Control	
9	9-423	Bracket	DVR Bracket	
10	4-601	Cable	2 meters long Spring cable with 6Pin Aviation socket	
11	A38001	Repair accessories	Cable front end maintenance accessories	
12	A32001	Bracket	Tool box bracket	

Part Number List

No.	Part Number	Part Name	Specifications	Picture
13	R3840U	Cable Wheel	<p style="text-align: center;">Φ6.8mm cable. push rod and keyboard text writer unit components Cable length: 40/50/60m(optional)</p>	
14	R3850U			
15	R3860U			
16	M3840U	Cable wheel and frame	<p style="text-align: center;">Include frame, coil, cable, push rod and keyboard text writer unit components Cable length: 40/50/60m(optional)</p>	
17	M3850U			
18	M3860U			
19	M3240U	Cable wheel and frame	<p style="text-align: center;">Include frame, coil, cable, push rod and keyboard text writer unit components Cable length: 40/50/60m(optional)</p>	
20	M3250U			
21	M3260U			
22	A18001	Toolbox unit	<p style="text-align: center;">Include DVR panel , control panel , wireless keyboard , remote control, adapter, car charger, 5mm screwdriver</p>	
23	A18009	Cable	<p style="text-align: center;">2 meters long Spring cable with 6Pin Aviation socket</p>	
24	K7924K	Wireless keyboard	<p style="text-align: center;">Wireless keyboard and receiver</p>	
25	8-956	POM Skid	<p style="text-align: center;">134mm POM Skid</p>	
26	8-967	POM Skid	<p style="text-align: center;">78mm POM Skid</p>	
27	8-978	ball skid	<p style="text-align: center;">60mm POM ball back support</p>	
28	8-989	Lock Sleeve	<p style="text-align: center;">POM Skid Lock Sleeve</p>	