

## Packing List

Item	Name	Quantity
1	Camera head	1pcs
2	Cable reel	1pcs
3	DVR control unit	1pcs
4	Video Link cable(6pin)	1pcs
5	Meter counter link cable(8pin)	1pcs
6	Camera skid	1set
7	Working platform	1pcs
8	32G USB disk	1pcs
9	Charge adaptor	1pcs
10	Waterproof ring	2pcs
11	Microphone	1pcs
12	Earphone	1pcs
13	User manual	1pcs
14	Tool bag	1pcs

## **AHD PT CAMERA INSPECTION SYSTEMS WITH DVR AND MANUAL FOCUS ASSEMBLY AND OPERATING INSTRUCTION**



**Read these instructions completely before operating the device  
PLEASE CHARGE BATTERY FIRST BEFORE USE!**

## Contents

Specification.....	2
Camera head.....	4
How to install camera skid.....	5
Control box panel.....	5
Remote controller.....	7
Cable reel & Meter counter .....	8
Control panel basic operation.....	9
Switch power supply between charge and battery.....	10
Charge the battery.....	10
Wireless keyboard operation instruction.....	11
Recording video & photography function instructions.....	11
DVR menu operation instruction.....	12
Troubleshooting guide.....	19
Packing List.....	20

## Attention

- 1) Please read the user manual carefully,
- 2) Please format the USB flash disk or USB hard disk on the DVR control box before first use the product
- 3) Using wireless keyboard, please make sure the battery for keyboard is full. If battery is low, it needs to change a new 7<sup>th</sup> battery.
- 4) Using original charger adaptor to charge battery or support unit work.

## Troubleshooting guide

**Q: All parts are connected well ,but there is no image on the screen.**

**A:**



Find 1m test cable, connect camera to control box directly, please check if the camera has image.

**Q: I can't typewrite words**

- A:**
1. Check the wireless keyboard battery is full or not.
  2. Check the wireless keyboard receiver if it is inserted well .  
If not , please restart the system after reinserting
  3. Please press below keys on the keyboard  
**F8**----Display the character  
**F9**--- Hide the character  
**F10**-- Clear all characters

**Q:The control box can't read USB flash disk**

**A:** Please use another USB flash disk to test. If the product still can't read this , please contact with us.

**Q: The meter counter is not accurate**

**A: Please check if the counter value is correct or not.**

**Video clip time:**1 MINUTE / 5 MINUTE / 10 MINUTE  
 15 MINUTE / 30 MINUTE / 60 MINUTE  
 Default value: 30 MINUTE

**FRAME RATE:**NTSC 30FPS / PAL 25FPS

**Video Quality:** It has 5 options. Usually we choose Level 3.  
 The level is bigger, the video resolution is higher

**Compress:**H265

**Photo Quality:** High / Middle / Low  
 Default Value : High

**Record Mode:** Manual / Auto  
 Default Value : Manual

**Overwrite:**OFF/ON  
 Default Value : OFF

## Specification

Monitor		
Screen size	13 inch LCD IPS screen	
Display Ratio	16:9	
Resolution	1280x720	
Menu	Chinese English and others	
Sunshade function	Yes	
Audio power amplifier		
Power Amplifier	Stereo Class-D Audio Power Amplifier	
Power	3W*1	
HD DVR		
Support playback file format	video	H.264 encode, MP4 format
	Audio	audio and video
	Picture	JPEG
Audio input	Built-in Microphone	
Video input	AHD analog high-definition signal(suport	
Signal input	CAM	
Video system	AHD PAL、AHD NTSC (Support CVBS	
Video Input	Stereo aduio output (Internal Audio or	
Video Output	Composite video signal output	
Power support		
External charge	DC12V (Input voltage AC 100V~240V, Output voltage DC:12.5V, Current 3000mA)	
Battery	11.1V 8800mA/H	

Power	20W (Max)
Battery charge time	6hours
Battery work time	8~10 hours
<b>Pan Tilt camera head with manual focus (512hz transmitter option)</b>	
Camera Diameter	Dia.50mm x L154mm
View range	+/- 180°, rotation endless (slip ring)
Lighting	6pcs white LEDS
Camera Sensor	1/3 CMOS, 1.3MP 960P
Operating temperature	5°C ~ 50°C
Camera housing material	304# Stainless steel
Waterproof	IP68
<b>Cable wheel</b>	
Special gold point touch connector to camera	
Fiberglass rod push cable Ø7mm	
Cable length: <input type="checkbox"/> 60 meters	
<b>Other function</b>	
Meter counter	Feet and Meter switch. Display on the screen
Keyboard	Support wired and wireless keyboard.



Adjust the LCD screen brightness, Contrast  
Default resolution:1280x720\_60

**Usually we suggest the customers don't change these value**

### RECORD Setting

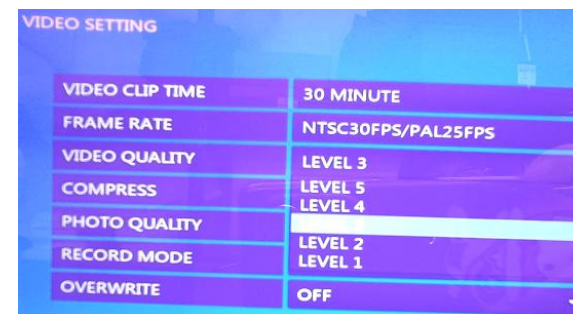
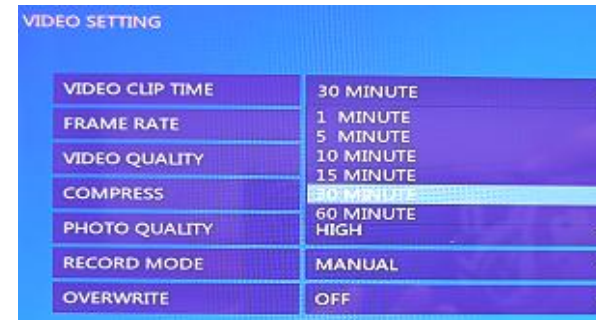

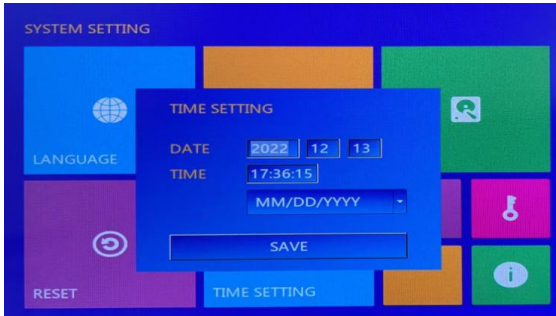

**Know Your Device**

- Camera head**
1. White LED lights (6 PCS)
  2. Lens
  3. Tilt rotation axis
  4. Aluminum housing
  5. Camera rear-end

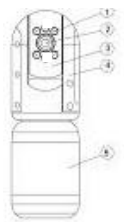

Press UP/Down/Left/Right arrows to set the date and time.  
 Press "Save" to save the setting

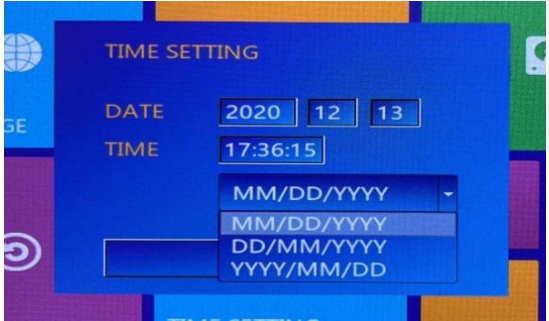

For date format, it has 3 options

**IMAGE SETTING**

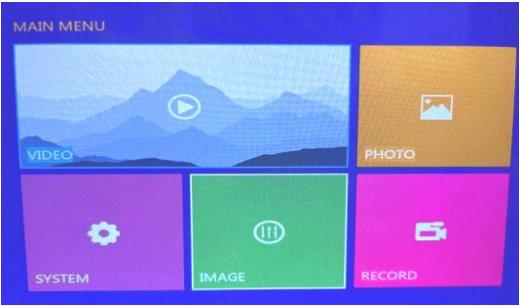

**Camera skids**

It includes below items.  
 2pcs/set (Diameter 85mm and Diameter 153mm)  
 6pcs spare wings for middle size (Diameter 220mm)

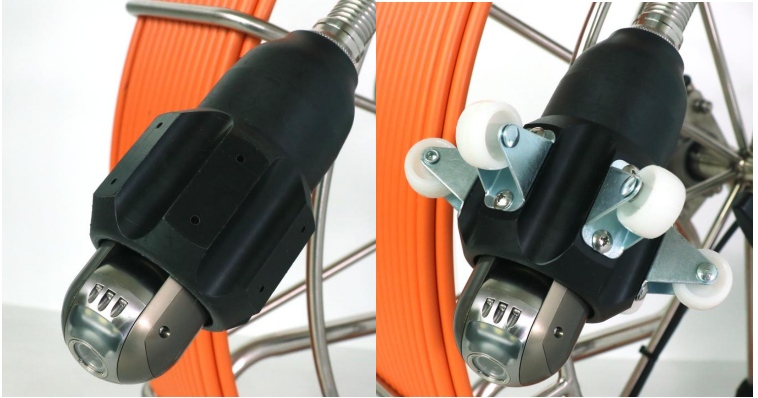

## How to install camera skid

### Step1:



### Step2:



### Step3:



### Step4:



## Control box panel

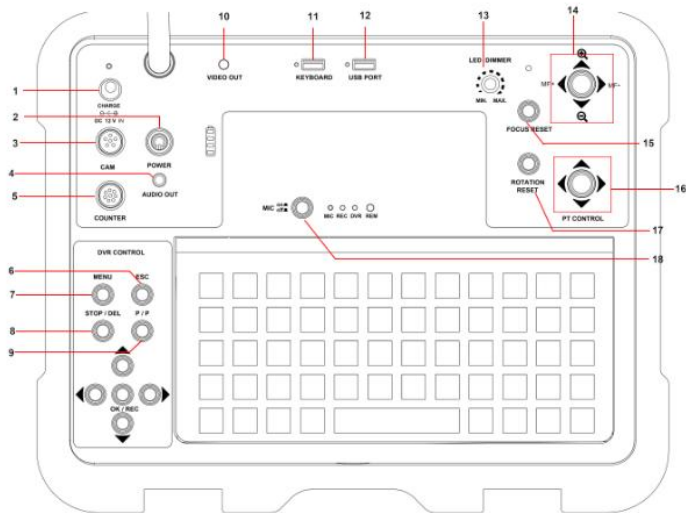

2) **ENCODER:** Set the value to get the accurate meter counter

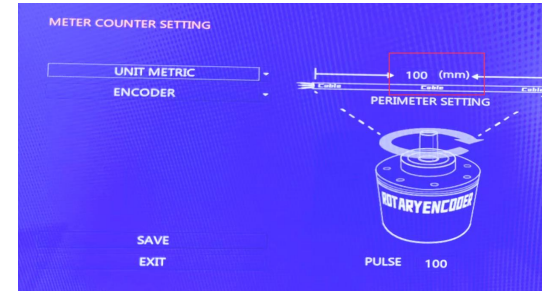

The **PREMETER SETTING** value is different for different cables.

For 7mm/9mm/11mm fiberglass cable, it is 100

For 8mm orange color soft cable, it is 157

For 6.5mm black color soft cable, it is 152

3) **DISK:** Format the USB flash driver.



The default value is "DISK1".

4) **RESET:** Restore the factory default Settings

5) **TIME SETTING:** Setting the time, date

Press the "UP" and "DOWN" arrows to select files  
 Press the "LEFT" and "RIGHT" arrows to turn pages,  
 Press "OK/REC " button to play the file, "STOP/DELETE " button to delete the file.

**2.PHOTO:** Playback the picture file

**3.SYSTEM:**Setting language,date,time ...

**4. IMAGE:** Image setting,such as CVBS out, HDMI Resolution,brightness,chroma, contrast, noise reduction

**5.RECORD:** Video setting, such as video clip time, frame rate, compress, photo quality, record model,overwrite.

### System Setting



1) **LANGUAGE:** Setting the menu language.  
 The box has 9 languages.(English,Chinese,French, Espanol German,Polish,Korea,Russian and Italian.

- 1) CHARGE : Indicating charging status
- 2) POWER:12V/1A power input
- 3) CAM:Camera channel
- 4) AUDEO OUT: Stereo audio output (Using this audio output, Speaker will cut off automatically)
- 5) COUNTER: Meter counter connector port
- 6) ESC:Exit
- 7) MENU
- 8) STOP/DEL :Stop recording or delete
- 9) P/P: Pause / Photography
- 10) VIDEO OUT
- 11) KEYBOARD: Connect wireless or wired keyboard
- 12) USB PORT: Connect external USB flash disk storage device
- 13) LED DIMMER: Adjusting LED brightness
- 14) ZOOM IN / OUT AND FOCUS :

 Zoom in

 Zoom out

MF+ :Far focus

MF-: Near focus

15) FOCUS RESET

16) PT CONTROL:



17) ROTATION RESET

18) MIC BUTTON:MIC on/off

## Remote controller



Button	Function
REC	Recording video
SNAP	Screenshot / Photography
▲	Up / Zoom in
▼	Down / Zoom out
◀	Left/Backward(Playback Model)
▶	Right/Forward(Playback Model)
OK	Confirm
MENU	DVR menu
STOP	Stop recording
ESC	Exit
PLAY	Playback the video
DEL	Delete the video or picture file

## Operating instruction

1. Insert the USB disk to USB port.
2. **Record the video:** press “OK/REC” button to start, and press “STOP” button to stop recording.
3. **Record the audio:** Insert the external microphone to MIC port. Press down the MIC button. When it is recorded the video, you can record the audio at the same time.
4. **Take pictures:** Press remote control “SNAP” button or control box “P/P” to take picture (No matter whether it is recording or not)
5. Press MENU button to enter the main menu ,and choose “VIDEO” to play the video.
6. Press MENU button to enter the main menu ,and choose “PICTURE” to scan the pictures.

## DVR menu instructions

Press menu button to enter the main menu

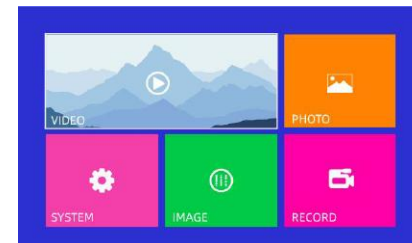

### 1. Video: Playback the video file





## Wireless keyboard operation instruction

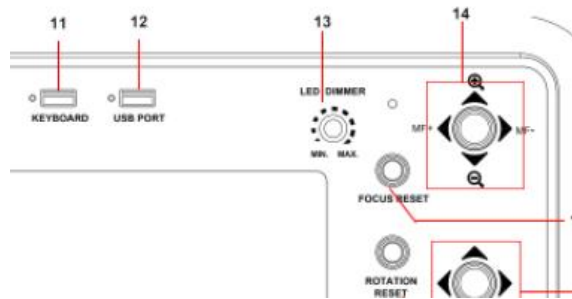

1. Inset USB adaptor to Keyboard USB port (No.11)
2. Switch Knob to "ON", The screen display cursor, then typewrite the character.
3. F8 :Display the character    F9:Hidden the character  
F10 :Clear the character
4. If the keyboard battery is low level, please change a new one. Otherwise it can't typewrite the character.

## HD DVR recording video & photography function instructions

Switch knob to "On" position, turn on the control unit box.



## Cable reel part Structure part

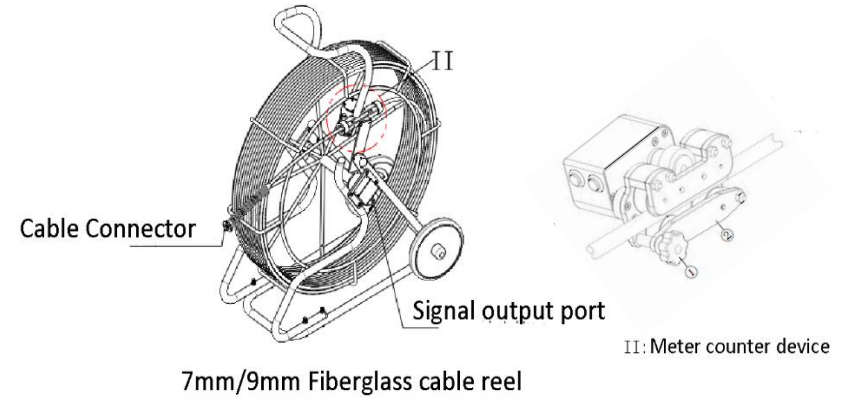

## Fixing the cable to meter counter slot

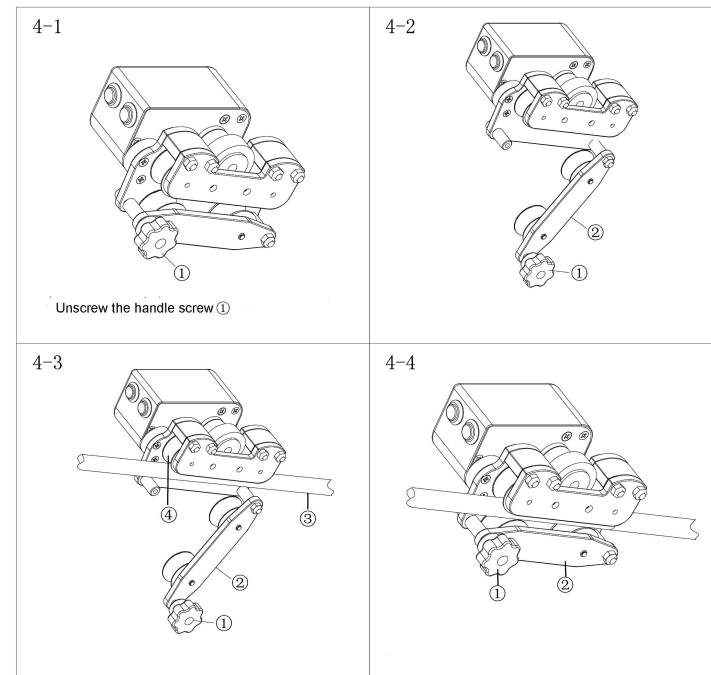

## Meter counter device part

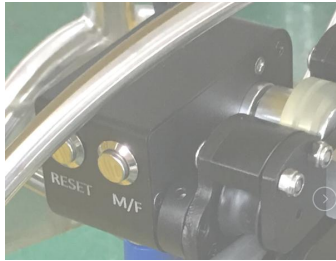

No.	Function	Details
1	RESET	Press this button ,the counter is zero
2	M/F	Switch Meters and Feet ; Default value is Meter

## Connecting cable reel to control box

A) Using 8 pin link cable to connect cable reel “counter” with Control box “Counter”port

B) Using 5pin link cable to connect cable reel “5pin port” with Control box” CAM” port

## Control panel basic operation

### Signal Input

Connect correct correspondingly link cable with CAM and counter channels.

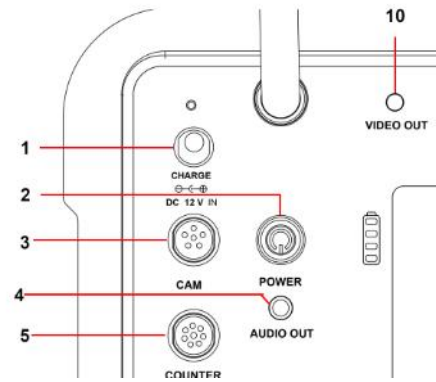

## Charge the battery

Inset 12.5V/2A adaptor to **(No.1)**

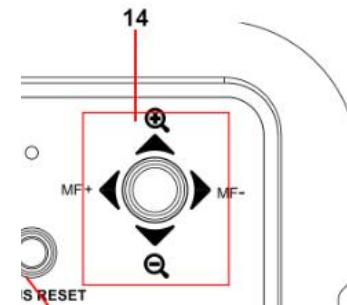

## ZOOM IN / OUT AND FOCUS



Zoom in



Zoom out

MF+ :Far focus

MF-: Near focus