

PIPE & WALL VIDEO INSPECTION SYSTEMS USER MANUAL

For
3688 SERIES

ASSEMBLING AND OPERATING INSTRUCTIONS



Read instructions carefully before operating this system

WARNING

1. Never use this device in an environment with explosive materials such as GAS, OIL, ETC.
2. Avoid using the device in extremely cold, hot or humid environment; otherwise it may damage the device. Do not drop or press hard on the device.
3. Avoid using the parts / components from other manufacturers to this system, which may damage the equipment due to the un-compatibility.
4. Warranty invalidation if the device is disassembled by users or if there are any physical damages.
5. Always back up your data before connecting your USB stick / Micro SD Card to this system. The manufacturer is not responsible for any data damage or loss on your USB stick / Micro SD Card for any reason.
6. Do not disconnect the unit while recording or playing. It may damage the unit and/or the USB stick / Micro SD Card.
7. Don't misuse the Battery Charger Cable and Power Cord, otherwise the battery pack may be damaged or the system can not work properly.
8. The system's PUSH CABLE made of fiberglass is very rigid and not flexible. It CAN NOT be bent sharply or pushed too hard; otherwise it will be broken.
9. If you have an extra portable cable reel, and try to put it in the case after use, you must put it in the right position; otherwise, LCD monitor may be broken by the part on the reel when you close the case.
10. Pleases forgive that if any change of products will not make additional specify in advance.

CONTENTS

Assembly Drawing and Parts Lis t.....	1
Specifications	2
User Manual	2
Know Your Device	3- 6
Remark	7
Counter.....	7
Pan-Tilt Camera	7-8
Cable Reel.....	9
Remote Control(For Operating DVR and SD Card Recording).....	9-10
System Set-Up.....	10
System Menu Setting.....	11
DVR/Micro SD Recording Operation.....	12
LED Indicators.....	13
Recording Time Limit.....	13
Recording via USB Stick/ Micro SD Card.....	13
Video Recording Format.....	13
Voice Recording	14
Video Playing.....	14
Select the Video File.....	14
Fast Forwarding and Rewinding.....	14
Compatible Video Format.....	14
How to use the text writer.....	15-16
Video Player Software Installation.....	17
Recharge the Battery.....	18
Trouble Shooting	19

Assembly Drawing and Parts List

Part No.	Description
1	PAN&TILT CAMERA
2	□10 INCH MONITOR
3	□60M(200FT) □90M(300FT) □120M(400FT) CABLE
4	POWER ADAPTER&BATTERY CHARGER
5	Multi-function case
6	SKIDS SCREW (12 PCS)
7	CAMERA SKIDS
8	3M or 5M VIDEO CABLE
9	REMOTE CONTROL
10	DISC



Specifications

Item	Description
Power adapter	110VAC~240VAC 13.5VDC 1700mA
Battery (In the case)	LI-ION battery, DC 12V, 6600mAh
Length of Cable	□60M(200FT) □90M(300FT) □120M(400 FT)
Camera Light Source	Built-in White LED lights (18PCS)
Camera Angle-of-View	Camera swing angle: 180° Camera Inclination Detection: 1. Measuring range: -90°~+90° 2. Resolution: 1°
Camera Rotating Angle	360°
Camera Image	Effective Pixel Array: 976 (H) x 504(V)
Monitor Screen Size	7" OR10" TFT LCD Color Monitor
Monitor Picture Resolution	800*600 pixel (for 10" LCD) 800*480 pixel (for 7" LCD)
Monitor Input Voltage	12 Volts DC
System Operating Temperature	-20°C to 55°C

User Manual

Application

1. WATER SUPPLY
2. WASTE WATER
3. ELECTRICAL AIR CONDITIONER
4. CABLE DUCTING
5. DUCTED VACCUM SYSTEMS
6. PLUMBING
7. BUILDINGS

WARNING:

NEVER USE THIS DEVICE IN AN ENVIRONMENT WITH EXPLOSIVE MATERIALS SUCH AS GAS, OIL, ETC.

Know Your Device

Control Box 3688C Function Box

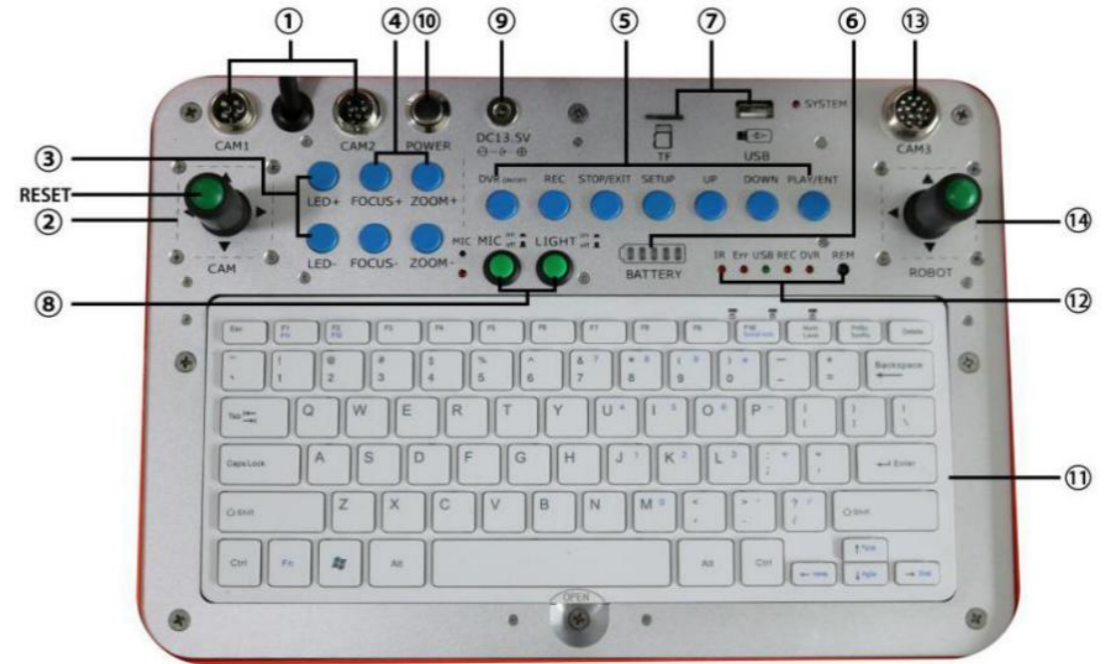
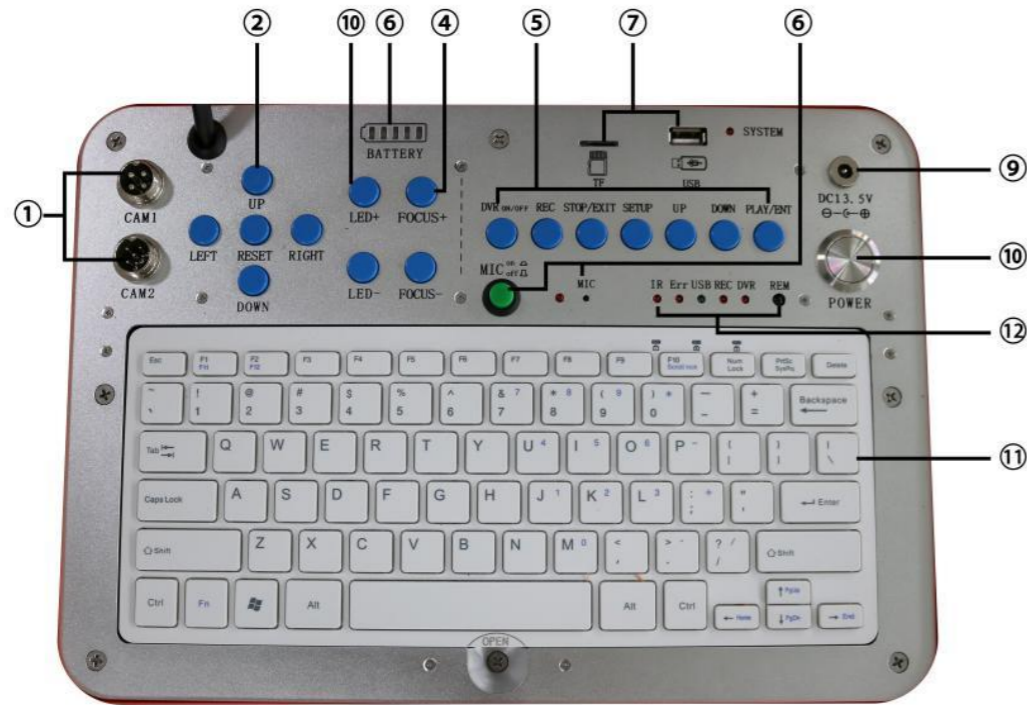

- ①、 Camera Input
CAM1: Common camera (four core interface) .
CAM2: 360° rotation camera (five core interface) .
- ②、 360°Rotation Camera Button/Rocker
LEFT: Control camera rotate to the left.
RIGHT: Control camera rotate to the right.
UP: Control camera rotate to the upward. (It's Zoom+ function when it's used for controlling CF50 camera.)
DOWN: Control camera rotate to the downward. (It's Zoom- function when it's used for controlling CF50 camera.)
RESET: Camera reset.
- ③、 LED+: Increase the brightness.
LED-: Decrease the brightness.
- ④、 FOCUS+: Adjust the lens focal length+.
FOCUS-: Adjust the lens focal length -.
ZOOM+: Control the lens zoom in.
ZOOM-: Control the lens zoom out.
- ⑤、 DVR Control Button
REC: Record video button.
STOP/EXIT: Exit DVR video playing or return to the next higher level submenu.

3688C(Single Rocker) Function Box.

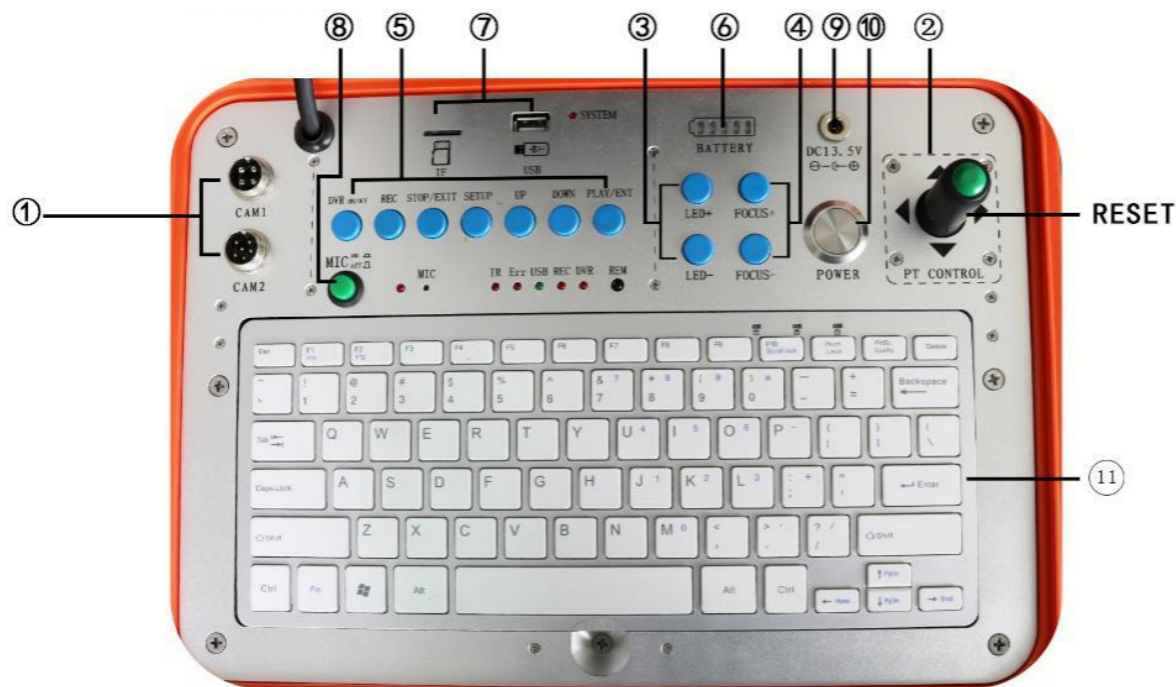

3688D Function Box

SETUP: DVR system setup.

UP: DVR user menu up operation button.

DOWN: DVR user menu down operation button.

PLAY/ENT: DVR play or select button.

⑥、BATTERY: Battery indicator.

Discharge instructions state: as the battery keeps discharging, the green indicator light will be out one by one, when the green light into flashing red lights, it means the battery volume is insufficient. Please recharge the battery.

Charging indicator status: with increase of battery charging, the green light will be lighted up one by one; when the green light turns into the bright green, the battery is fully recharged.

⑦、USB& TF Pin

When use U disk & TF card as a storage device, please insert the right port.

⑧、MIC on/off: MIC switch. When need the tape at the process of video, press the switch, indicator lights up, work in MIC recording condition. After the end of the video, you must press the switch again, otherwise there is no audio signal output.

LIGHT on/off: Crawl robot auxiliary lighting witch.

⑨、The power adapter input. Can be used as the machine power supply or charging the battery.

⑩、POWER: Power switch.

⑪、Keyboard Input

Using the keyboard to input character (English letters、Numbers and symbols), this is a new equipment which can input characters superposing on the real-time monitoring images, showing three lines of characters below the display line.

⑫、LED Indicators

IR: The remote control work lamp.

ERR: Indicator system or USB device error.

USB: When users insert a new USB&TF card, this indicator shining.

REC: Video recording work lamp.

DVR: DVR Indicator system work.

REM: Remote control receiving window.

⑬、Camera and Crawl Robot Interface

CAM3: 360°rotation camera and crawl robot (15 core interface).

⑭、Crawl Robot Rocker

LEFT: Control the crawl robot to the left.

RIGHT: Control the crawl robot to the right.

UP: Control the crawl robot to the upward.

DOWN: Control the crawl robot to the downward.

Display Part



①、VIDEO

②、MENU

③、DOWN

④、UP

⑤、SEL

⑥、LED ON/OFF

⑦、REM

⑧、POWER

⑨、10" LCD

Remark:

1) MENU key-press : Image adjust. Press SEL/DOWN/UP key to adjust below numerical value. Numerical value is from 0 to 100. Language has ENGLISH,DEUTSCH,FRANC,ESPAKOL,PORTUG,ITALIANO,ENGLES, PNCKK

BRIGHT-----50
CONTRAST-----50
COLOR-----50
SHARP-----50
LED BRIGHT-----80
HUE-----50
ENGLISH

After exit "MENU" mode, below keys have different functions:

- 2) DOWN: Press DOWN key, the image change UP and DOWN (Mirror function)
- 3) UP: Press UP key, the image change LEFT and RIGHT (Mirror function)
- 4) SEL key: Press SEL key to change the image to 16:9 image or 4:3 image (except 10 inch monitor)

Counter:

Cable with meter counter

1. Reset
2. Metric & Imperial conversion

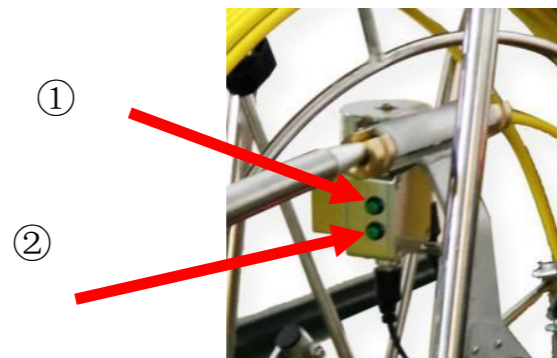

PAN-TILT Camera



I. Working environment:

1. Temperature: -20°C ~ +55°C
2. Humidity: 90%RH (non-condensation)

III. Main Technical Indicators:

1. **Power source input: DC 9~15V,8W (maximum)**
2. **Camera module:**
 - 1) Image sensor: 1/3 Inch CMOS PC1099
 - 2) Effective Pixel Array: 976 (H) x 496(V)
 - 3) Horizontal resolution: 900 TVL
 - 4) Minimum illumination: 0.01LUX/F1.2
 - 5) SNR: >45dB
 - 6) Video Output: 1 Vp-p / 75 Ohms
 - 7) Input voltage: DC 9-15V
 - 8) Current consumption: 60mA-200mA
3. **Swing motor:**
 - 1) Camera swing angle: 180°
4. **Rotating motor:**
 - 1) Camera rotating angle: 360°
5. **Focus motor:**
 - 1) Can adjust 20 steps.
6. **Lighting source:**
 - 1) LED quantity: 18pcs
 - 2) Luminous flux: 107~114 lm (180 mA)
 - 3) Working Current: 0~200 mA
 - 4) Light Cup Angle: 45°
7. **Camera Inclination Detection:**

- 1) Measuring range: -90°~ +90°
- 2) Resolution: 1°

8. 485 communication:

- 1) Baud rate: 9600 Bit/S,8 data bits,1 stop bit, no parity
- 2) Isolation voltage: 560V
- 3) ESD protection: ±15KV
- 4) Transient simulation capabilities: 25KV/us
- 5) Improve protection: Fault (open circuit, short circuit) protection, thermal shutdown protection

IV. External Interface:

Camera Interface: includes 485, power supply, video signal. 8-pin socket. Pin 1 to 8 are separately connected to GND, VIDEO, +12V, 485_B, 485_A,NC, NC, NC.

Cable reel

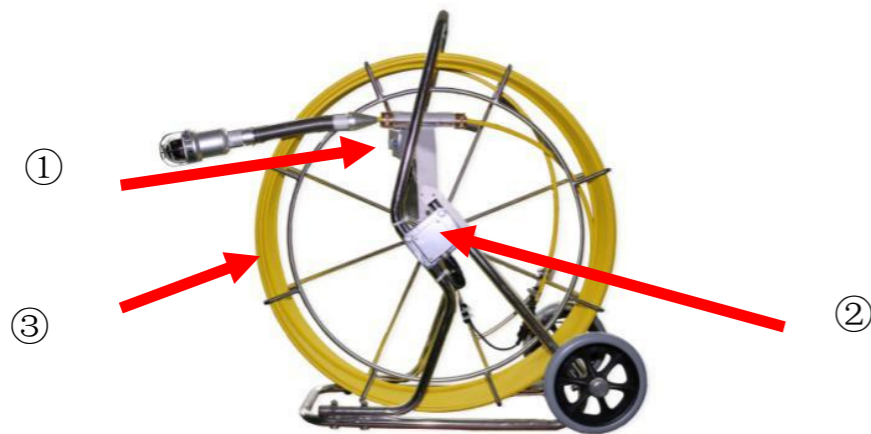

1. Meter Counter Box
2. Female Plug
3. Cable Wheel

Remote Control (For Operating DVR and SD Card Recording)

- 1) Enter: Enter to view and play video
- 2) Up: Go to up/previous item

- 3) REC: Start recording/ Snap Shooting (only available for new version)
- 4) SETUP: System setup and recording features
- 5) POWER: System in
- 6) Down: Select down/next item
- 7) STOP: Stop or escape from current menu
- 8) Left: Select Left item
- 9) Right: Select Right item
- 10) Rewind: Review video
- 11) Forward: forward video

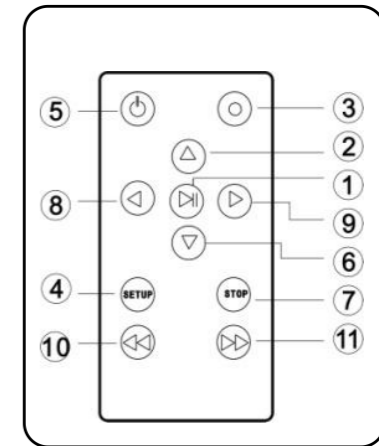

System Set-Up

1. IMPORTANT: When you connect the Camera to the Monitor, the power must be off; otherwise both units will be damaged.
2. Connect the reel cable to the Monitor.
3. Plug the Power Adapter cord into the wall AC socket and the other end into the "DC 13.5V" jack .

Note : Don't misuse the Power Cord and Battery Charger Cable, otherwise the system can not work properly, or the battery pack may be damaged.

4. Press the POWER button on the front of the Monitor.
5. Gently lower the Camera into a pipe duct, etc and reel out the Cable until it is at the desired depth.
6. Record the pictures if you need (see DVR Operating).
7. Video Out: By using a video cable you can transfer the picture to other larger Screen.
8. When you finish the job, carefully remove the Camera head from the pipe duct, etc, clean it with a clean, soft and dry cloth and then put the Camera into the previous position





System Menu Setting

Clock setting: set date and time	
*Time Format	Select: 24Hour - 12Hour
Year	Set year
Month	Set month
Day	Set day
Hour	Set hour
Minute	Set minutes
Second	Set seconds
Language Setting	Select: English - Chinese
System: showing software version, product version, free space and used space (when USB/ Micro SD Card is connected)	
Record setup: Storage Device Selection ---USB Device or Micro SD card	
Play Mode: No circle, One circle, List circle	
Master reset: press OK again to perform a master reset	
Firmware update: locate the directory where new firmware is stored	
Browse File:Showing all files on the current USB/ Micro SD Card medium.	
Remove USB/Micro SD Card device (only when USB/Micro SD Card device is connected)	
Always use this option before safely removing the USB /Micro SD Card device from the USB/Micro SD Card port	

Remark: When you plug in the USB key/Micro SD card before starting the device, maybe the device can't find the USB stick/Micro SD card. In this case, please remove them and try again.

DVR/Micro SD RECORDING OPERATION

(Recording via MICRO SD Card is only available for the new versions)

1. Set the Screen Video Button on Video 2.
2. Take off the isolation sheet from the Remote Control Battery.
3. Press the Remote Control Button 5  to enter the Recording system, you can see DVR system Recorder **PLAY VIDEO** manual on the screen.
4. Insert your USB stick/ removable hard disc etc into the **USB** Port, or Micro SD Card into Micro SD Card Slot, you can see **USB stick/ Micro SD Card Connected** on the screen and the LED light indicator is on.
5. Press Remote Control Button 3  to start the recording and the RECORDING LED light is on. In recording, if you press the RECORDING button again, the DVR will take a photo and it is saved in the USB key or Micro SD card (only available for new versions).
6. Press Remote Control Button 7  to stop recording.
7. Press Remote Control Button 1  to review recording.
8. If you need to manage your recorded pictures, press Remote Control Button 4 . You can also manage the files by selecting the **SETTING** on **PLAY VIDEO** manual on the screen.

NOTE:

DVR system sometimes need 10 - 20 seconds for reposition before it can work properly, please let it run about 20 seconds each time when you try to record. USB flash disk and Micro SD card max memory is 8G bit.

LED Indicators

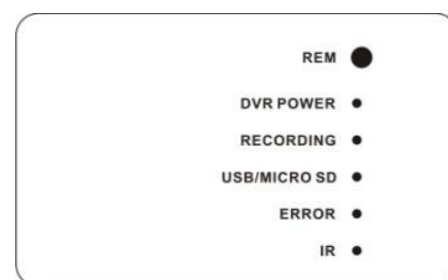

- 1) REM : Remote receiving window
- 2) Power: It indicates that the DVR system is on
- 3) Recording: It will blink during recording
- 4) USB/Micro SD: It indicates that USB stick/Micro SD is connected
- 5) Error: It indicates that the system or USB device has error
- 6) IR: It blinks when the remote control is in use for **Recording Video**

The recorded video files will be found in a directory of USB/Micro SD devices.

You can use the on-screen menu or press (REC) button to start recording. Press (■/EXIT) button to stop recording. During the recording, the screen will display recording time and time limit (up to 60 minutes).

Recording time limit

Sometimes you may forget to stop the recording after it is initiated. This unit is featured with a recording time limit. The default time limit is 60 minutes. If recording time over 1 hour, the system will record with a new file

Schedule recording

You can schedule a recording in advance. Simply enable the schedule recording in the SETUP and then the unit will ask user to setup timing. Recording schedule can be used once. You have to set up schedule again for next recording.

Recording via USB Stick / Micro SD Card

The unit can be used to record video and voice via USB devices / Micro SD Card .The recorded video will be stored in the USB devices / Micro SD Card and played back on the TV screen.

Video recording format

The default video recording resolution is 640*480. One-hour recording will take up storage of 500MB. User may select 320*240 to save storage space.

Voice recording

A microphone button located on the front panel allows the user to press the button on to record a voice while the video is recording (This function is only available for new versions).

Video Playing

You can use on-screen menu to enter “play video” mode. The unit will display the recorded video and other compatible videos stored in USB stick / Micro SD Card. It will not list the non-compatible videos.

Select the Video File.

When you enter “play video” mode, the set will display all of the available video files on the screen.

You can use [▲] or [▼] button to select desired video and press [▶/ENT] button to play.

Press and hold [▲] or [▼] button to go to previous or next video.

Use [▶/ENT] button to start or pause the playing .Use [■/exit] button to stop or go back to previous menu.

The screen will display “loading, please wait ...” for a few seconds before playing video.

Fast Forwarding and Rewinding

You can use [▶] or [◀] button on the remote control to fast forwarding or rewinding (1x, 2x, 4x, or 8x, speed). Always press [▶/ENT] button to go back to normal playing.

Compatible video format:

Divx3.11/Divx4/Divx5/MPEG1/MPEG2/MPEG4 (MPEG4 video file format: .avi, .m4v, .MPG, MPEG, .VOB)

Note: The video player of the device may not support some downloaded videos.

How to use the text writer?

With the signal overlay technology, the text writer is a device that can display the input characters from the keyboard (only supporting English input). Keyboard input function is basically the same as the computer keyboard operation.



I. Keyboard Functions

1. It supports the display of 3 pages.
2. The keyboard has a 0-9 number input with symbol switching through the Shift + “key”
3. 26 English letters input and case switching with Caps Lock.
4. F5 is the character display/hide switch key. When you press F5, all the characters are hided. Press F5 again, all characters are displayed.
5. Move the cursor through the four arrow keys of the keyboard to enter the character at the position where you want.
6. Keys:
 - 1) See Appendix 1 for other punctuations, Appendix 2 for function keys.
 - 2) Keys without functions: Esc、 F1、 F2、 F3、 F4、 F6、 F7、 F8、 F9、 F10、 Num Lock、 Prtscsysrq、 Tab、 Ctrl、 Fn、 Alt

II. How to Operate

1. To start the device, press the VIDEO button below the monitor to enter the VIDEO2 channel
2. After DVR is empowered, press the DVR ON/OFF button to turn off the DVR and then the screen will enter the preview state. At this time, there is the flashing cursor"|" on the screen.

3. After the normal display of the cursor, press the DVR ON/ OFF button on the control panel to turn on the DVR. You can now record videos, take snapshot or input the text on the screen.

Appendix 1: Punctuations

,	°	()	?
:	;	*	/	@
-	<	>		

Appendix 2: Function Keys

F5	Display/hide character switch
Caps lock	Case Switching
Four arrow keys	Up, Down, Left and Right Movement
Backspace、 Delete	To delete
Enter	Enter Key
Shift+ Key	Input the symbol on the corresponding key
space key	Space bar

Video Player Software Installation

Generally, the recorded videos can be played on the computer purchased after the year 2006. If you can not open the recorded document on computer, there are two options:

Option 1: Go to the website “ <http://www.kmplayer.com/> ” and download the KMPlayer software for free.

Option 2: Install the Media Player Software with the Disc

- Steps:
1. Create a new folder on the computer
 2. Put the disc in the computer drive, open the files in the disc and copy all the files to the above new folder on the computer.
 3. Click fullplaye.exe in the new folder

csfcodec	2018/5/9 14:45
hotkey	2018/5/9 14:45
lang	2018/5/9 14:45
UPD	2018/4/16 14:38
binkw32.dll	2014/8/13 11:02
CSMX.dll	2014/8/13 11:02
dh264.ax	2014/8/13 11:02
Esdll.dll	2014/8/13 11:02
fullplayer.exe	2014/8/13 11:02
haalis.ax	2014/8/13 11:02
install.exe	2014/8/13 11:02
ir41_32.ax	2014/8/13 11:02
ir50_32.dll	2014/8/13 11:02
ivm.dll	2014/8/13 11:02
IVMSource.ax	2014/8/13 11:02
mc.dll	2014/8/13 11:02
media.db	2014/8/13 11:02
Microsoft.VC90.CRT.manifest	2014/8/13 11:02
mkunicode.dll	2014/8/13 11:02
mkzlib.dll	2014/8/13 11:02
mmamrdmx.ax	2014/8/13 11:02
mp4.dll	2014/8/13 11:02
msvcr90.dll	2014/8/13 11:02

Open the media player



Click the icon “Open File” and choose the videos in AVI format to open.

Recharging the Battery

- 1) Plug the charger into the AC socket on the wall and insert the other end into the DC jack (See Figure2-A).
- 2) The battery can be charged while the device is being used. However, once the power in the battery runs completely out, it can only be charged when the device is turned off.



Figure 2

IMPORTANT MESSAGE: Do not overcharge the battery! Overcharging can result in acid leaking from or damage to the battery.

Battery specifications:

1. TOTAL POWER $\leq 15W$
2. LI-ION BATTERY 12VDC MAX. $\leq 79Wh$
3. CHARGER 13.5V 1700mA
4. CHARGE TIME 6 HOURS
5. WORKING TIME ≥ 200 MINUTES
6. PROTECTIVE VOLTAGE 8.1 V
7. THE VOLTAGE BEFOR DISCHARGING 12.6V
8. LOAD CURRENT 1200mA(INPUT 12.2V)

TROUBLE SHOOTING

Trouble	Reason / Solution
Blank screen	1. Change the fuse
	2. Recharge the battery
	3. Check power line and connect it again.
No signal	1. Read the manual again and reconnect it.
	2. Check the camera and screw down
	3. Clean the camera pins
	4. Check the pins and find if they are in the same level
The camera has weak or no light	Press the "MENU" button, locate the LED brightness setting and then adjust the brightness.
No recording	1. Press the "Video" button and change to Video2
	2. Press POWER button and the monitor indicator light is green.
	3. Use another USB stick /micro SD and try
Recording abnormality	Shut off the unit and restart the unit in correct steps
Flashing pictures	1. Deficiency of the battery power. Please recharge the battery
	2. Misuse of the charger cable and power cord: switch the cables
No working of battery recharging	Misuse of the charger cable and power cord : switch the cables