

Packing List

Item	Name	Quantity
1	Camera head	1pcs
2	Cable reel	1pcs
3	DVR control unit	1pcs
4	Video Link cable(6pin)	1pcs
5	Meter counter link cable(8pin)	1pcs
6	Camera skid	1set
7	Working platform	1pcs
8	32G USB disk	1pcs
9	Charge adaptor	1pcs
10	Waterproof ring	2pcs
11	Microphone	1pcs
12	Earphone	1pcs
13	User manual	1pcs
14	Tool bag	1pcs

AHD PT CAMERA INSPECTION SYSTEMS WITH DVR AND MANUAL FOCUS ASSEMBLY AND OPERATING INSTRUCTION



**Read these instructions completely before operating the device
PLEASE CHARGE BATTERY FIRST BEFORE USE!**

Contents

Specification.....	2
Camera head.....	4
Camera skid.....	4
Control box panel.....	5
Remote controller.....	7
Assemble cable to meter counter.....	8
Charge the battery.....	9
Wireless keyboard operation instruction.....	10
Assemble the equipment.....	10
DVR menu operation instruction.....	12
Troubleshooting guide.....	18
Packing List.....	19

Attention

- 1) Please read the user manual carefully,
- 2) Please format the USB flash disk or USB hard disk on the DVR control box before first use the product
- 3) Using wireless keyboard, please make sure the battery for keyboard is full. If battery is low, it needs to change a new 7th battery.
- 4) Using original charger adaptor to charge battery or support unit work.

Troubleshooting guide

Q: All parts are connected well ,but there is no image on the screen.

A: Find 1m test cable (picture2), connect camera to control box directly, please check if the camera has image.



Q: I can't typewrite words

- A:**
1. Check the wireless keyboard battery is full or not.
 2. Check the wireless keyboard receiver if it is inserted well .
If not , please restart the system after reinserting
 3. Please press below keys on the keyboard
F8----Display the character
F9--- Hide the character
F10-- Clear all characters

Q:The control box can't read USB flash disk

A: Please use another USB flash disk to test. If the product still can't read this , please contact with us.

Q: The meter counter is not accurate

A: Please check if the counter value is correct or not.

Video clip time:1 MINUTE / 5 MINUTE / 10 MINUTE
 15 MINUTE / 30 MINUTE / 60 MINUTE
 Default value: 30 MINUTE

FRAME RATE:NTSC 30FPS / PAL 25FPS

Video Quality: It has 5 options. Usually we choose Level 3.
 The level is bigger, the video resolution is higher

Compress:H265

Photo Quality: High / Middle / Low
 Default Value : High

Record Mode: Manual / Auto
 Default Value : Manual

Overwrite:OFF/ON
 Default Value : OFF

Specification

Monitor		
Screen size	13inch LCD IPS screen	
Display Ratio	16:9	
Resolution	1280x720	
Menu	Chinese English and others	
Sunshade function	Yes	
Audio power amplifier		
Power Amplifier	Stereo Class-D Audio Power Amplifier	
Power	3W*1	
HD DVR		
Support playback file format	video	H.264 encode, MP4 format
	Audio	audio and video
	Picture	JPEG
Audio input	Built-in Microphone	
Video input	AHD analog high-definition signal(suport	
Signal input	CAM	
Video system	AHD PAL、 AHD NTSC (Support CVBS	
Video Input	Stereo aduio output (Internal Audio or	
Video Output	Composite video signal output	
Power support		
External charge	DC12V (Input voltage AC 100V~240V, Output voltage DC:12.5V, Current 3000mA)	
Battery	11.1V 8800mA/H	

Power	20W (Max)
Battery charge time	6hours
Battery work time	8~10 hours
Pan Tilt camera head with manual focus (512hz transmitter option)	
Camera Diameter	Dia.50mm x L154mm
View range	+/- 180°, rotation endless (slip ring)
Lighting	6pcs white LEDS
Camera Sensor	1/3 CMOS,1.3MP 960P
Operating temperature	5°C ~ 50°C
Camera housing material	304#Stainless steel
Waterproof	IP68
Cable wheel	
Special gold point touch connector to camera	
Fiberglass rod push cable Ø9.0mm or 11mm	
Cable length: <input type="checkbox"/> 60 meters <input type="checkbox"/> 80 meters <input type="checkbox"/> 120 meters	
Other function	
Meter counter	Feet and Meter switch. Display on the screen
Keyboard	Support wired and wireless keyboard.

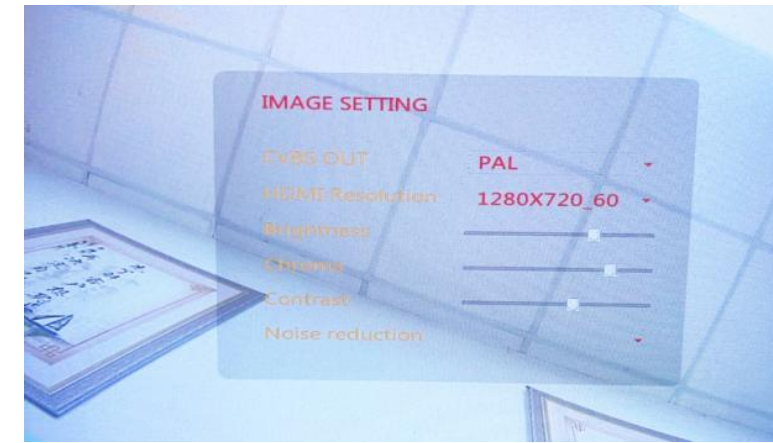

Adjust the LCD screen brightness, Contrast

Default resolution:1280x720_60

Usually we suggest the customers don't change these value

RECORD Setting

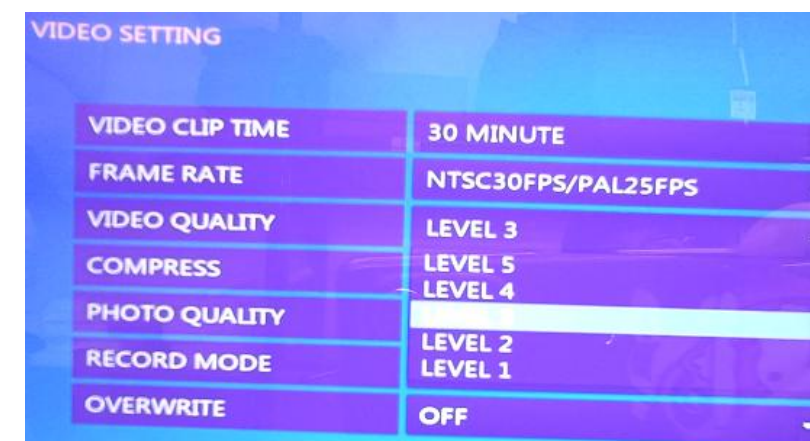
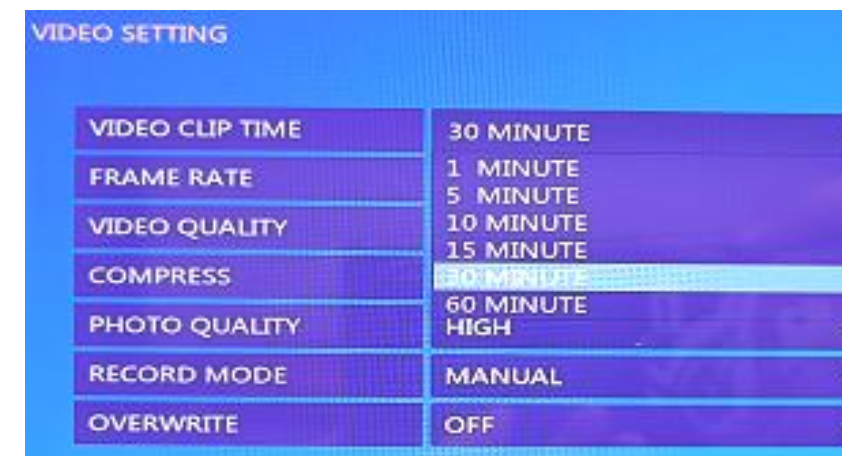

Know Your Device

Camera head

1. White LED lights (6 PCS)
2. Lens
3. Tilt rotation axis
4. Aluminum housing
5. Camera rear-end

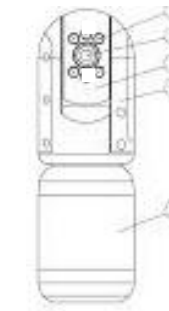

Camera skids

It includes below items.

2pcs/set (Diameter 85mm and Diameter 153mm)

6pcs spare wings for middle size (Diameter 220mm)

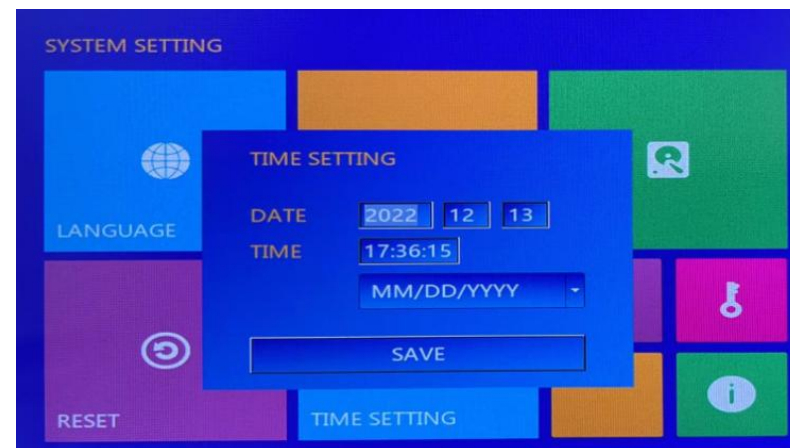

Press UP/Down/Left/Right arrows to set the date and time.

Press "Save" to save the setting

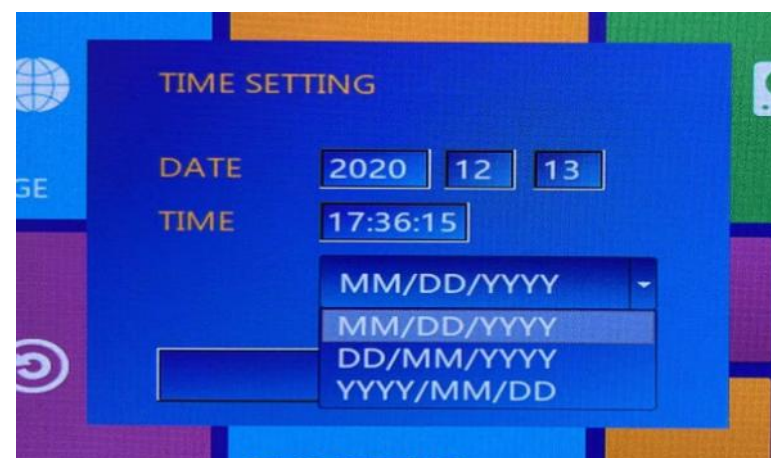





For date format, it has 3 options

IMAGE SETTING



How to install camera skid

<p>Step1:</p> 	<p>Step2:</p> 
<p>Step3:</p> 	<p>Step4:</p> 

Control box panel

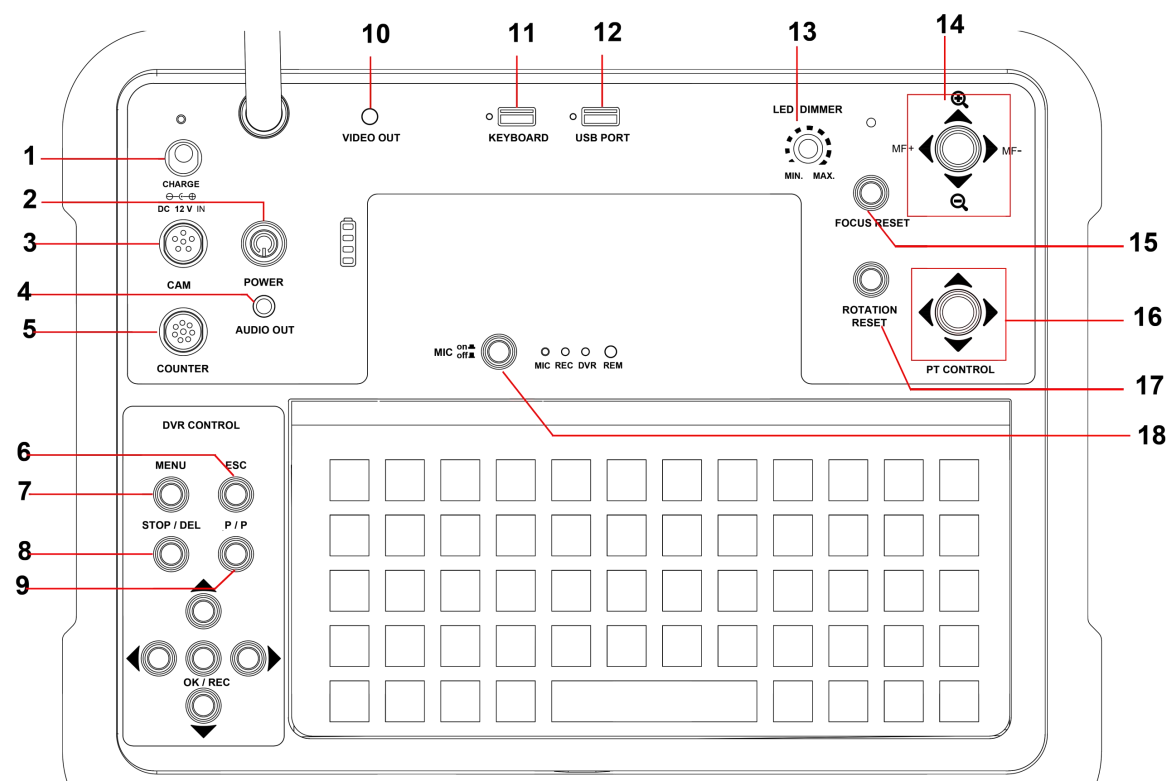

2) **ENCODER:** Set the value to get the accurate meter counter

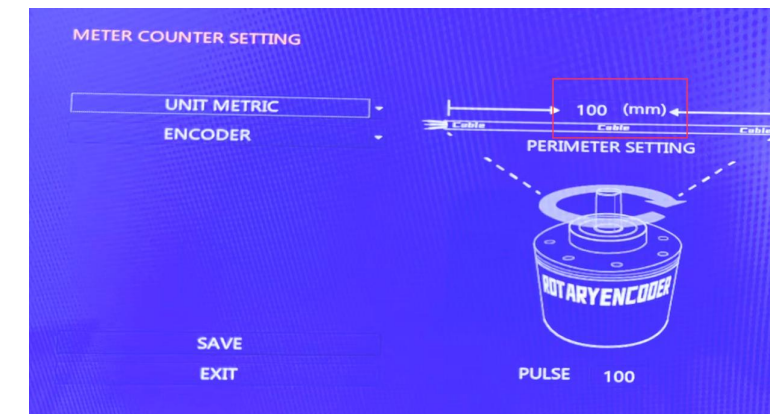

The **PREMETER SETTING** value is different for different cables.
 For 7mm/9mm/11mm fiberglass cable, it is 100
 For 8mm orange color soft cable, it is 157
 For 6.5mm black color soft cable, it is 152

3) **DISK:** Format the USB flash driver.

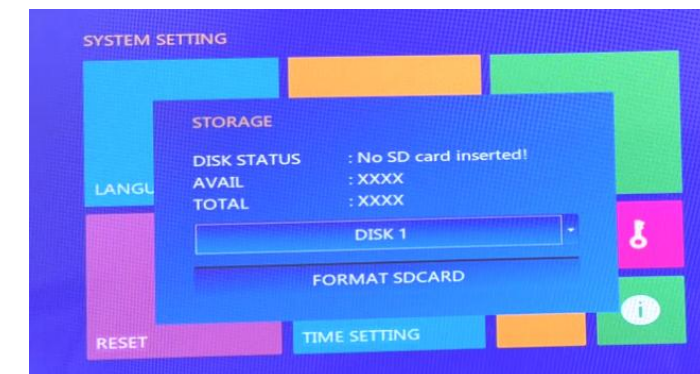

The default value is "DISK1".

4) **RESET:** Restore the factory default Settings

5) **TIME SETTING:** Setting the time, date

Press the "UP" and "DOWN" arrows to select files

Press the "LEFT" and "RIGHT" arrows to turn pages,

Press "OK/REC " button to play the file, "STOP/DELETE " button to delete the file.

2.PHOTO: Playback the picture file

3.SYSTEM:Setting language,date,time ...

4. IMAGE: Image setting,such as CVBS out, HDMI

Resolution,brightness,chroma, contrast, noise reduction

5.RECORD: Video setting, such as video clip time, frame rate, compress, photo quality, record model,overwrite.

System Setting



1) **LANGUAGE:** Setting the menu language.

The box has 9 languages.(English,Chinese,French, Espanol German,Polish,Korea,Russian and Italian.

1) CHARGE: Insert charge adaptor,charge the battery.

2) POWER: Power key.Press it down, turn on the conton box.

3) CAM: 6pin port .Signal input.

4) Audio out:Connect external earphone

5) COUNTER: 8pin port. Connect meter counter link cable

6) ESC:Exit

7) Menu: DVR main menu

8) STOP/DEL: Stop recording the video . Delete the files in menu

9) P/P:Pause / Photography

Up: Move up /Zoom in Down:Move down /Zoom out

Right:Move right Left:Move Left

OK/REC: Confirm / Record the video

10) Video out: Video output.(Connect outside monitor)

11) KEYBOARD: Connect wireless or wired keyboard

12) USB PORT: Connect external USB flash disk storage device

13) LED DIMMER: Adjust camera led brightness

14) Joystic: (Zoom function is only avaiable for zoom camera)

+ :Zoom out **-** :Zoom in

MF+ :Far focus MF-: Near focus

15) Focus reset:one key to original focus

16) PT CONTROL: Camera rotation joystick

17) Rotation reset: camera backs to original direction

18) MIC:record the auido.

Remote controller



Button	Function
REC	Recording video
SNAP	Screenshot / Photography
▲	Up / Zoom in
▼	Down / Zoom out
◀	Left/Backward(Playback Model)
▶	Right/Forward(Playback Model)
OK	Confirm
MENU	DVR menu
STOP	Stop recording
ESC	Exit
PLAY	Playback the video
DEL	Delete the video or picture file

Operating instruction

1. Insert the USB disk to USB port.
2. **Record the video:** press “OK/REC” button to start, and press “STOP” button to stop recording.
3. **Record the audio:** Insert the external microphone to MIC port. Press down the MIC button. When it is recorded the video, you can record the audio at the same time.
4. **Take pictures:** Press remote control “SNAP” button or control box “ P/P” to take picture (No matter whether it is recording or not)
5. Press MENU button to enter the main menu ,and choose “VIDEO” to play the video.
6. Press MENU button to enter the main menu ,and choose “PICTURE” to scan the pictures.

DVR menu instructions

Press menu button to enter the main menu

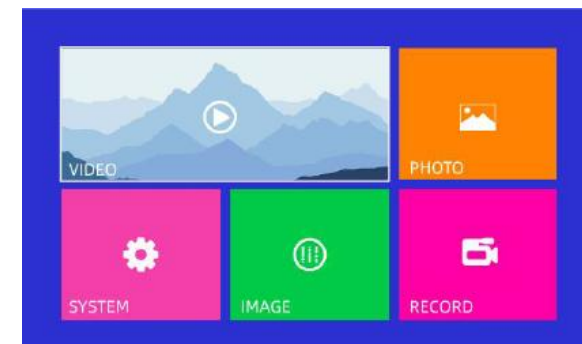

1. Video: Playback the video file

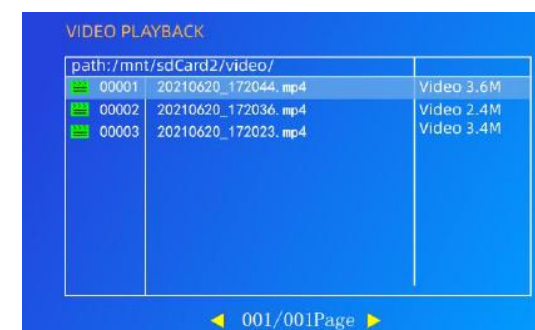

5. Open the control box, connect 2 link cables from control box to cable reel.

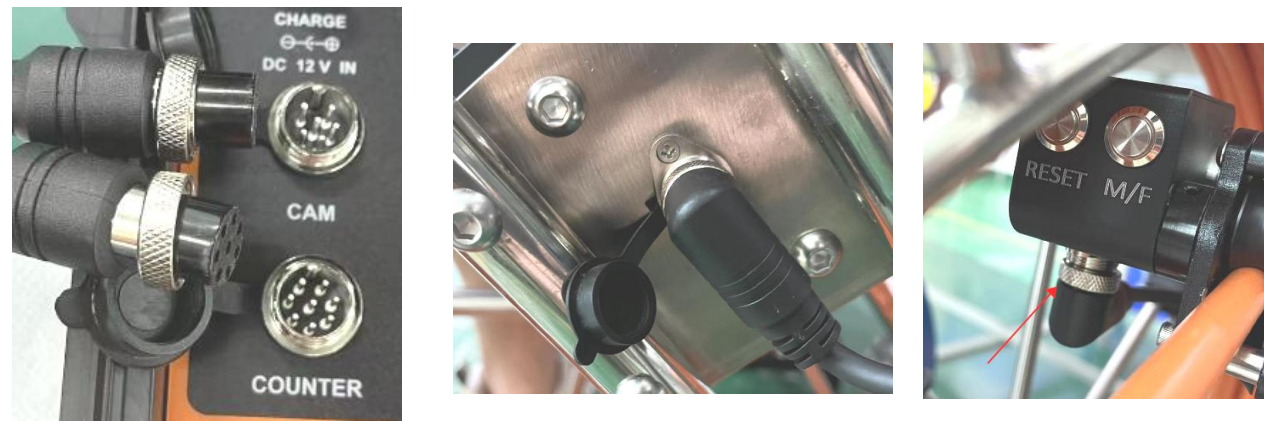

(To Control box: right-angle end)

(To cable reel: 90 degree end)

6. Take out the wireless keyboard adaptor from keyboard



7. Insert USB flash driver and Keyboard USB adaptor to the control box



8. Power on the control box.

**Cable reel part
Structure part**

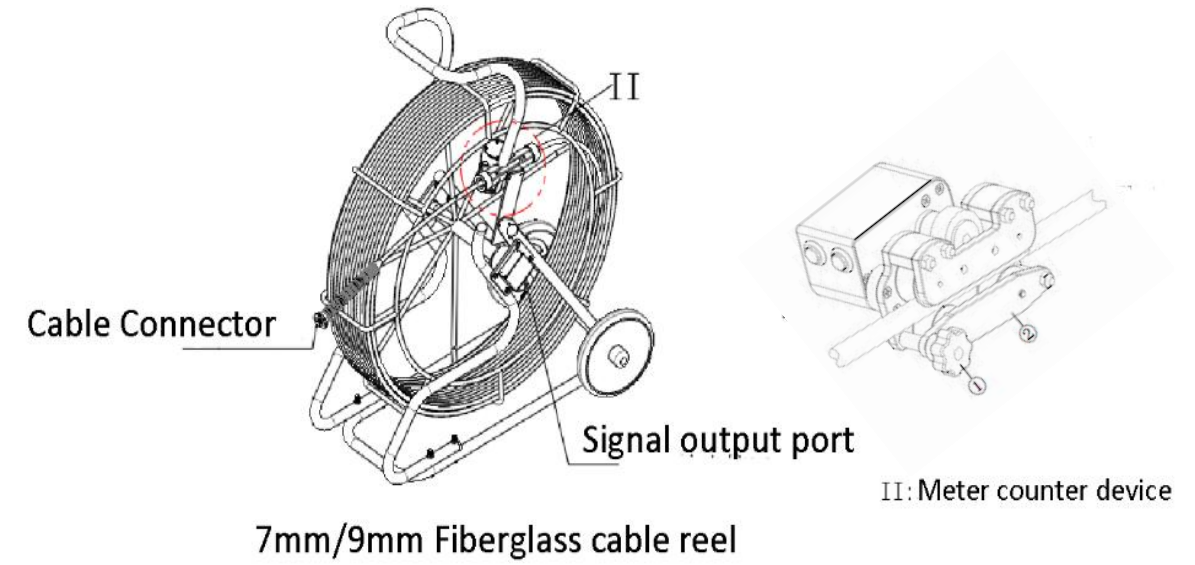

Fixing the cable to meter counter slot

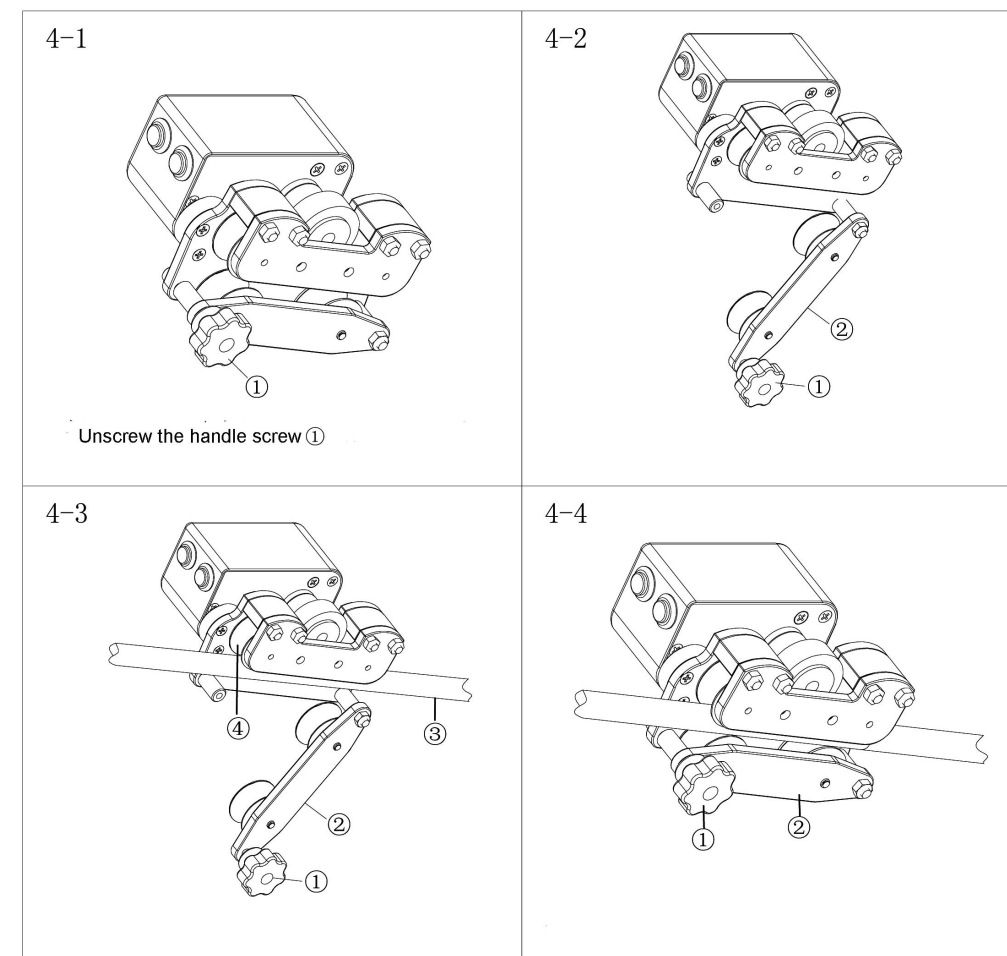

Meter counter device part

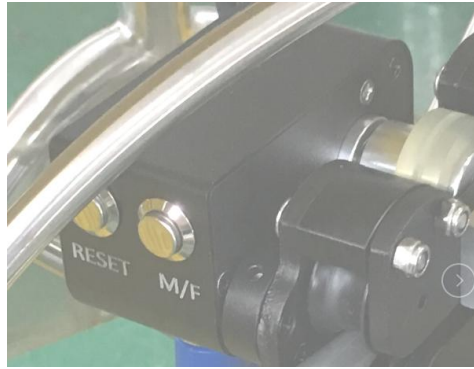

No.	Function	Details
1	RESET	Press this button ,the counter is zero
2	M/F	Switch Meters and Feet ; Default value is Meter

Charge the battery

- 1) Inset 12.5V/2A charge adaptor to charge port 1
- 2) Charge adaptor indicator light is red, the battery is charging
- 3) Charge adaptor indicator light is green, the battery is charged full

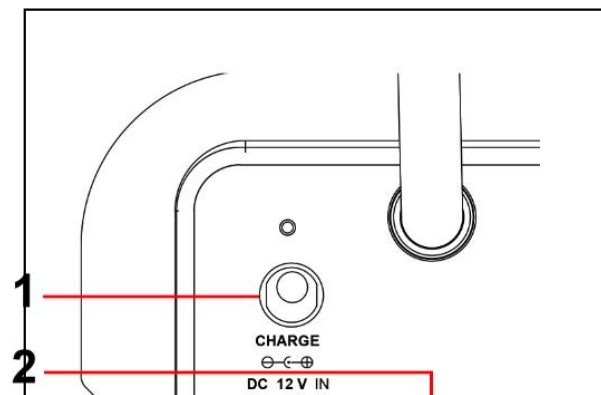

Wireless keyboard operation instruction

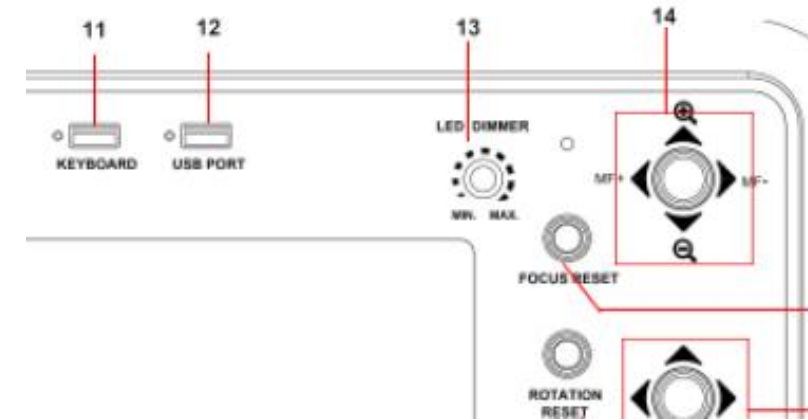

1. Inset USB adaptor to Keyboard USB port (No.11)
2. Switch Knob to “ON”, The screen display cursor,then typewrite the character.
3. F8 :Display the character F9:Hidden the character
F10 :Clear the character
4. If the keyboard battery is low level, please change a new one.
Otherwise it can't typewrite the character.

Assemble the equipment

1. Take out all parts from the package.Count the items as the packing list.
2. Install the cable to meter counter part. (Pic1)



(Pic1)



(Pic2)

3. Install the centralizer guide to cable reel. (Reference Page4)
4. Connect camera head to the cable reel.(Pic2)